

NEW LIFE TO YOUR COMFORT ZONE.



VERZELLONI



NEW LIFE TO YOUR COMFORT ZONE.



VERZELLONI



1950

## IDENTITY

Fondata nel 1950 Verzelloni è una storia di famiglia che si tramanda da più generazioni. Pensiamo e creiamo i nostri prodotti. Divani, divani componibili, poltrone, tavolini e librerie danno vita alla nostra collezione. Lavorazione attenta, sapiente scelta dei materiali e una forte identità stilistica: tutto questo è Verzelloni. Ci piace creare un prodotto dalle note familiari in cui ci si possa riconoscere e che sia un protagonista silenzioso del living contemporaneo. I nostri prodotti rispecchiano la nostra filosofia: crediamo in un design colto ed essenziale, che sappia emozionare con semplicità e al tempo stesso possa essere personalizzato e rispondere ai desideri dei nostri clienti per avere un prodotto che li faccia sentire al 100% loro stessi e pienamente soddisfatti. Questa filosofia è parte integrante dell'azienda che per sua natura è flessibile e si adatta alla realtà che la circonda creando un clima familiare che si rispecchia anche all'esterno. Un forte senso del dovere e un'etica del lavoro sincera e radicata ci hanno permesso di costruire rapporti di lunga durata con tutti i nostri clienti e collaboratori. L'innovazione e la ricerca sono alla base di ogni attività potenziando l'orientamento verso prodotti più sostenibili e a ridotto impatto ambientale. Creare nuove opportunità senza dimenticare chi siamo è la sfida che ogni giorno ci spinge a migliorare e a anticipare le esigenze future.

Founded in 1950, Verzelloni is a family business that has been passed down through the generations. We design and develop our own products. Our range includes sofas, modular sofas, armchairs, small tables, and bookcases. Attention to detail, carefully selected materials, and a strong brand identity are what Verzelloni is all about. We like to create a product which resonates in peoples' lives, with which they can identify, and which reflects contemporary living. Our products reflect our philosophy - we believe in an elegant yet minimalist design, which knows how to excite with simplicity and which, at the same time, can be customized and respond to our customers' desire for products that make them feel 100% themselves and entirely satisfied. This philosophy is an integral part of the company, which by its nature is flexible and able to adapt to the surrounding environment by creating a family atmosphere that is also reflected on the outside. A strong sense of duty and a sincere and rooted work ethic have allowed us to build long-lasting relationships with all our customers and partners. Everything we do is based on innovation and research as well as our commitment to creating more sustainable products with minimal environmental impact. Creating new opportunities without forgetting who we are is the challenge that drives us every day to improve and to anticipate future needs.

2 Seit dem Gründungsjahr 1950 ist Verzelloni unsere über Generationen weitervererbte Familiengeschichte. Wir studieren und kreieren unsere Produkte. Sofas, modulare Sofas, Sessel, Couchtische und Bücherregale beleben unsere Kollektion. Sorgfältige Verarbeitung, kluge Materialauswahl und eine starke stilistische Identität: All das ist Verzelloni. Wir lieben es ein Produkt mit familiärer Note zu schaffen, in dem man sich wiedererkennen kann und das ein stiller Protagonist zeitgenössischen Wohnens ist. Unsere Produkte spiegeln unsere Philosophie wider: Wir glauben an ein kultiviertes und essentielles Design, das mit Schlichtheit zu begeistern weiß und gleichzeitig individualisierbar ist und auf die Wünsche unserer Kunden eingeht, damit sie ein Produkt haben, mit dem sie sich zu 100 % identifizieren können und voll zufrieden sind. Diese Philosophie ist fester Bestandteil des Unternehmens, das seiner Natur gemäß flexibel ist, und sich an seine umgebende Realität anpasst um eine familiäre Atmosphäre zu schaffen, die sich auch nach außen widerspiegelt. Ein starkes Pflichtbewusstsein und eine aufrichtige und verwurzelte Arbeitsmoral haben es uns ermöglicht, langanhaltende Beziehungen zu all unseren Kunden und Mitarbeitern aufzubauen. Innovation und Forschung sind die Basis jeder Aktivität und stärken die Ausrichtung auf nachhaltigere Produkte mit geringerer Umweltbelastung. Neue Möglichkeiten zu schaffen, ohne zu vergessen, wer wir sind, ist die Herausforderung, die uns jeden Tag antreibt, uns zu verbessern und zukünftigen Bedürfnissen vorzugreifen.

1950

VERZELLONI



COLLEZIONI - COLLECTIONS - KOLLEKTIONEN

# COLLECTIONS



Davos 6



Lyndon 14



Emily 28



Holden 36



Zoe 48



Nilson 64



Nilson Lounge 78



Irving 80



Larsen 94



Divanitas 106



Fold 118



Hampton 130



Hampton Memory 140



Itaca 144



Noe 148



Joe 160

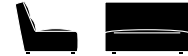

Link 170



Elliot 180



Patty 188



Rubik 194



Sillón 200



Kelly 206

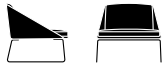

Cubica 214



Calvino 220



Robin 224



Planet 226



Antero 228



Etan 230



Jim e Jules 234

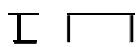

Club 236



Argo 240



Global Quality 242



Technical Info 244



LIEVORE + ALTHERR, DÉSILE, PARK

Davos è una collezione dalla linea arrotondata e dal design elegante e rigoroso, caratterizzata da un'elevata comodità grazie all'altezza dello schienale.

Davos collection has a rounded line and an elegant and rigorous design, it offers high comfort thanks to the height of its backrest.

Davos ist eine Kollektion mit Rundungen und einem eleganten und strengen Design, das sich, dank der Höhe der Rückenlehne, durch hohen Komfort auszeichnet.

# DAVOS

















Davos\_ divano 270 e pouf 120x60\_ sofa 270 and pouf 120x60\_ Sofa 270 und Hocker 120x60

CRD VERZELLONI

Linea classica e contemporanea, lussuosa ed elegante, Lyndon è caratterizzato da un morbido e accogliente bracciolo e da un cuscino di seduta dallo spessore elevato in contrapposizione con la base sottile che conferisce leggerezza alla struttura.

Classic and contemporary line with a luxurious and elegant look, Lyndon is characterized by an armrest with a welcoming form and by a high thickness seat cushion, supported by a thin base that gives lightness.

Klassisch und modern, luxuriös und elegant. Lyndon zeichnet sich durch eine weiche und bequeme Armlehne und durch ein hohes Sitzkissen aus, im Gegensatz zu der schmalen Linie der Basis, die der Struktur Leichtigkeit verleiht.

# LYNDON







Lyndon\_ Chaise longue SX 136 Base e dormeuse DX 224 Base  
Chaise longue SX 136 Base and dormeuse DX 224 Base\_ Chaiselongue SX 136 Basis und Dormeuse DX 224 Basis

















24

Lyndon\_ angolo 136 Base\_ corner 136 Base\_ Eckelement 136 Basis



Lyndon\_ dormeuse angolo SX 224 Base e laterale DX 244 2S  
corner dormeuse SX 224 Base and side piece DX 244 2S\_ Eckdormeuse SX 224 Basis und Seitenteil DX 244 2S



ALBERTO LIEVORE

Grazie alle dimensioni compatte e alla sua forma avvolgente ispirata a quella di una conchiglia, la poltrona Emily rappresenta il connubio ideale fra comodità ed eleganza per inserirsi con grazia negli spazi domestici e pubblici dedicati al relax.

Thanks to the compact dimensions and being inspired by the enveloping shaped of a shell, the armchair Emily represents the ideal combination of comfort and elegance, and gracefully fits both into residential and public areas dedicated to relax.

Dank seiner kompakten Abmessungen und seiner von einer Muschel inspirierten Form ist der Sessel Emily die ideale Kombination aus Komfort und Eleganz, um sich elegant in Wohn- und öffentliche Bereiche einzufügen, die der Entspannung gewidmet sind.

# EMILY

















CRD VERZELLONI

Forma rassicurante e concreta, elegante e confortevole, misure "generose". La collezione offre un'ampia gamma di divani, elementi, laterali, angoli che abbinati a piacere offrono innumerevoli combinazioni.

A reassuring, solid shape, elegant and comfortable, "generous" proportions. This collection presents a wide array of settees, side elements, corners that can form countless different combinations.

Beruhigende und konkrete Optik, elegant und bequem, großzügige Maße. Die Kollektion bietet eine breitgefächerte Serie an Sofas, Seiten-und Eckelemente, welche durch das Zusammenfügen nach freier Wahl unzählige Kombinationen bieten.

# HOLDEN

Divani - Divani componibili

2010

VERZELLONI









39

Holden\_ laterale 251 SX A, pouf 103 e pouf 120  
side piece 251 SX A, pouf 103 and pouf 120\_ Seitenteil 251 SX A, Hocker 103 und Hocker 120









43

Holden\_ laterale 251 SX A, dormeuse angolo 118 DX B e pouf 120  
side piece 251 SX A, corner dormeuse 118 DX B and pouf 120\_ Seitenteil 251 SX A, Eckdormeuse 118 DX B und Hocker 120











47

Holden\_ laterale 236 SX A Big e dormeuse angolo 103 DX Base  
side piece 236 SX A Big and corner dormeuse 103 DX Base\_ Seitenteil 236 SX A Big und Eckdormeuse 103 DX Basis

LIEVORE ALTHERR MOLINA

Zoe si distingue per il design informale e per il particolare comfort.  
ZOE, presentata per la prima volta nel 2006 e diventata in pochi anni un'icona del design.

Zoe distinguishes itself for its comfort and its casual design.  
ZOE presented for the first time in 2006 and become a design icon in just a few years.

Zoe zeichnet sich durch sein informelles Design und seinen besonderen Komfort aus.  
ZOE 2006 erstmals präsentiert und in wenigen Jahren zu einer Design-Ikone geworden.

# ZOE

# ZOE MORE

48

Poltrone

2006

VERZELLONI





















Zoe Punto Cavallo\_ Si tratta di un'impuntura decorativa disponibile in 11 colori da abbinare a piacere al tessuto scelto.  
Il tessuto è da selezionare fra quelli idonei.

Zoe Punto Cavallo\_ Decorative stitching available in 11 colours to be matched at pleasure with the fabric.  
Fabric has to be chosen among those specified as suitable.

Zoe Punto Cavallo\_ Ziernaht, die in 11 Farben erhältlich ist, kann mit den dafür geeigneten Stoffen,  
je nach Wunsch, kombiniert werden.



Cucitura Punto Cavallo\_ stitching Punto Cavallo\_ Zierstich Punto Cavallo

Zoe Punto Cavallo\_ poltrona Large e pouf 108\_ Large armchair and pouf 108\_ Sessel Large und Hocker 108



LIEVORE ALTHERR MOLINA

Nella versione Outdoor vengono impiegati tessuti idrofughi, resistenti ai raggi solari e agli agenti atmosferici, la fodera interna è anch'essa idrofuga ed entrambe sono cucite con filati speciali imputrescibili.

In outdoor version Zoe is delivered with water repellent as well as sun's ray and general atmospheric agents resistant fabric, under cover is provided with water repellent materials too, and both covers are sewed with mould resistant yarn.

Für die Outdoor Version werden wasserabweisende Stoffe verwendet, die gegen Sonnenlicht und Witterungseinflüsse resistent sind. Auch der Unterbezug ist wasserabweisend und beide sind mit speziellem und verwesungsbeständigem Garn genäht.

# ZOE OUTDOOR

60

Poltrone

2006

VERZELLONI









LIEVORE ALTHERR

Nilson è un modello dalla linea innovativa la cui caratteristica principale è l'elevata comodità.

Nilson is a model with an innovative design characterized by a high level of comfort.

Nilson ist ein Modell innovativer Linie, dessen Hauptmerkmal der hohe Grad an Komfort ist.

# NILSON

64

Divani - Divani componibili - Poltrone

2017

VERZELLONI







Nilson Basso\_ laterale SX 207, chaise longue DX e poltrona  
side piece SX 207, chaise longue DX and armchair\_ Seitenteil SX 207, Chaiselongue DX und Sessel















Nilson Alto\_ chaise longue SX, laterale DX 207 e poltrona  
chaise longue SX, side piece DX 207 and armchair\_ Chaiselongue SX, Seitenteil DX 207 und Sessel



Bracciolo fibra di cuoio\_ armrest leather fiber\_ Armlehne Bonded Leder



75

Nilson Basso\_ divano 253\_ sofa 253\_ Sofa 253







LIEVORE ALTHERR

A completamento della collezione Nilson è disponibile la poltrona Lounge, completa di pouf, che, nonostante le ridotte dimensioni, offre una elevata comodità grazie alla base basculante, oltre che girevole e con ritorno automatico.

The lounge armchair, with its pouf, completes the Nilson collection. Despite its reduced dimension, offers a high level of comfort thanks to the tilting as well as swiveling base with automatic return.

Der Sessel Lounge vervollständigt mit seinem dazu gehörigen Hocker die Kollektion Nilson. Trotz seiner reduzierten Maße bietet er gehobenen Komfort, auch dank seines Schwing- und Drehmechanismus mit Rückdrehaomatik.

# NILSON LOUNGE



Nilson Lounge\_ poltrone e pouf\_ armchairs and pouf\_ Sessel und Hocker

CRD VERZELLONI

Sistema di sedute dalla linea solida ed essenziale; alto da terra, è caratterizzato da un piede a ponte in fusione di alluminio che gli conferisce leggerezza e dinamismo.

Seating system distinguished by a solid and essential line; high from the ground, characterized by a bridge-shaped foot in aluminium cast that confers lightness and dynamism.

Das Modulsystem mit einer kompakten und essentiellen Linie, nicht bodennah, kennzeichnet ein brückenförmiger Fuß in Aluminiumguss, der ihm Leichtigkeit und Dynamismus verleiht.

# IRVING

80

Divani - Divani componibili

2016

VERZELLONI









Irving\_ poggiatesta\_ headrest\_ Kopfstütze

Irving\_ chaise longue 123 - 25A DX, terminale 199 A SX e pouf 99x99  
chaise longue 123 - 25A DX, end piece 199 A SX\_ and poufs 99x99\_ Chaiselongue 123 - 25A DX, Endelement 199 A SX und Hocker 99x99























CRD VERZELLONI

La linea pulita della scocca, unita al piede a ponte in fusione di alluminio, conferiscono dinamismo e leggerezza al modello Larsen, mentre le accoglienti e comode imbottiture donano morbidezza per un risultato di grande eleganza che rimanda ai modelli americani anni '60.

The essential design of the frame together with the bridge-shaped feet in aluminium cast give dynamism and lightness to the item Larsen, while comfortable padding lends softness for an elegant result recalling the American models of the '60s.

Minimalistische Linien des Korpus, verbunden mit dem brückenförmigen Fuß in Aluminiumguss, verleihen dem Modell Larsen Dynamismus und Leichtigkeit, während die einladenden und bequemen Polster Weichheit schenken. Das Resultat ist eine hohe Eleganz, die an die amerikanischen Modelle der 60er Jahre erinnert.

# LARSEN

























105

Larsen\_ love seat 120

LIEVORE ALTHERR MOLINA

Divanitas è la riedizione di un modello disegnato da Alberto Lievore & Asociados e realizzato da Verzelloni nel 1996. Il modello, che conserva la linea innovativa, sinuosa ed essenziale, della prima edizione, è stato rivisitato nelle proporzioni e nel comfort di seduta e schienale per meglio rispondere alle attuali esigenze abitative.

Divanitas is the new re-styling of a model designed by Alberto Lievore & Asociados and created by Verzelloni in 1996. The model preserves the innovative, sinuous and essential line of the first edition while it has been revised in the proportions and in the comfort of the seat and back to better meet the current housing needs.

Divanitas ist die Neuausgabe eines Modells, entworfen von Alberto Lievore & Asociados und von Verzelloni im Jahr 1996 realisiert. Das Modell, das die innovative, geschwungene und essentielle Linie der Erstausgabe bewahrt, ist in seinen Proportionen und seinem Sitzkomfort überarbeitet worden, um den heutigen Ansprüchen zu genügen.

# DIVANITAS





Cucitura versione pelle\_ seam leather version\_ Naht Lederversion























GARCÍA CUMINI

Fold, grazie alla profondità di soli 85 cm, è una collezione pensata per gli spazi contenuti e raffinati che si caratterizza nel suo design e nella sua personalità per una serie di cuciture che traggono ispirazione dal sistema di chiusura della busta.

Fold has been thought for limited but refined spaces, thanks to its depth of just 85 cm, where its particular stitching, reminding the sealing of envelopes, characterize the design and personality of this collection.

Dank seiner Tiefe von 85 cm, ist Fold eine Kollektion, die für etwas kleinere und elegante Räumlichkeiten gedacht ist. Ihre Nahtverarbeitung, die sich am Verschlussystem eines Kuverts inspiriert, charakterisiert ihr Design und ihre Persönlichkeit.

# FOLD

118

Divani - Divani componibili - Poltrone

2014

VERZELLONI





















127





CRD VERZELLONI

Linea elegante dalle studiate proporzioni conquista slancio e leggerezza grazie al piede a ponte in alluminio su cui poggia la struttura.

Elegant line and studied proportions, which obtain burst and determination through its bridge-shaped foot supporting the framework.

Schmale, brückenförmige Aluminiumfüße, die die gesamte Struktur stützen, betonen die elegante und harmonische Form des Modells.

# HAMPTON

130

Divani - Divani componibili - Poltrone

2011

VERZELLONI









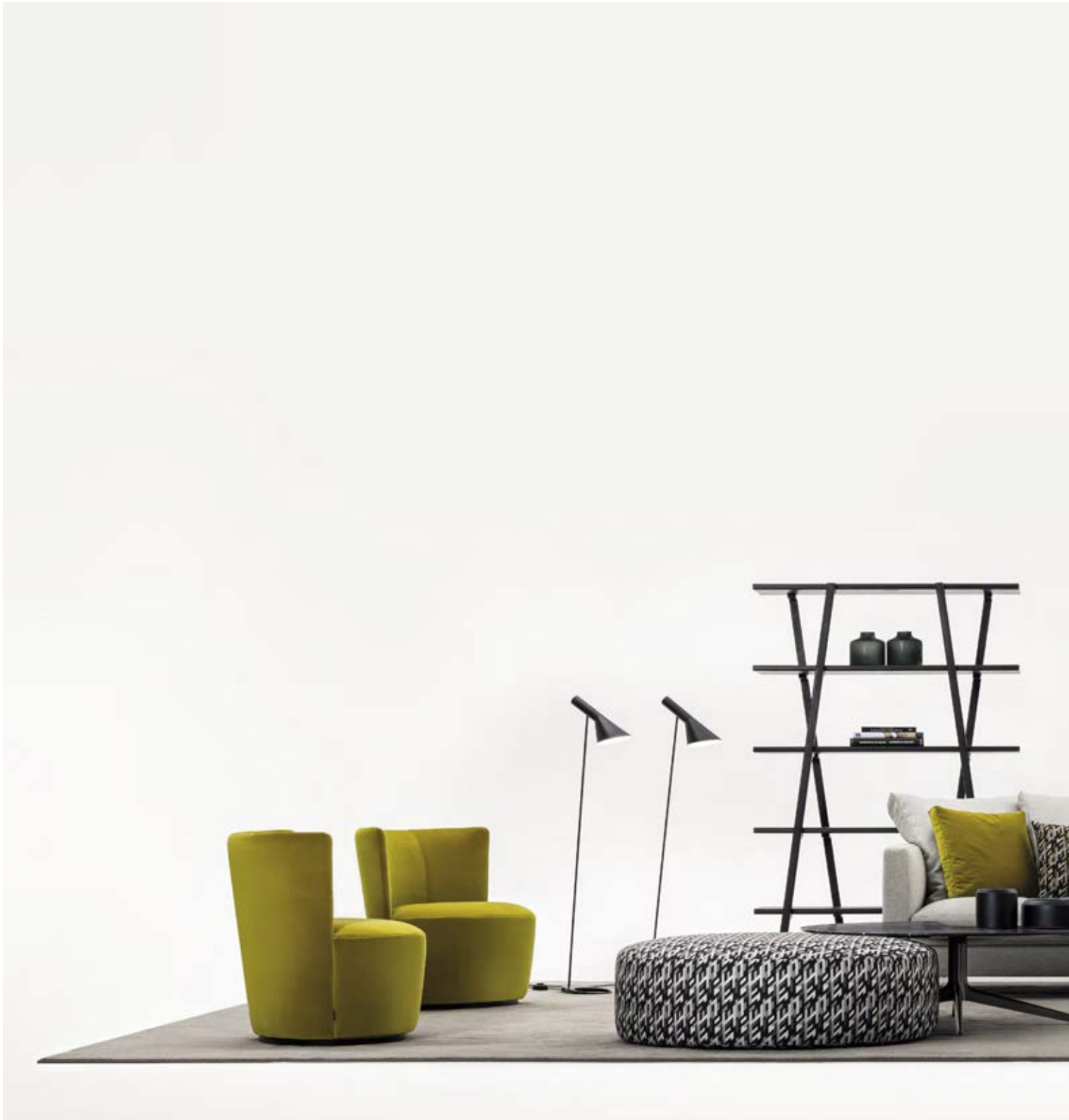



135

Hampton\_ laterale 236 SX Base e dormeuse angolo 239 DX Base  
side piece 236 SX Base and corner dormeuse 239 DX Base\_ Seitenteil 236 SX Basis und Eckdormeuse 239 DX Basis









CRD VERZELLONI

Linea elegante dalle studiate proporzioni, conquista slancio e leggerezza grazie al piede in alluminio a ponte su cui poggia la struttura. Il cuscino di seduta a martello rivisita in chiave moderna il classico divano senza tempo.

Elegant line and studied proportions, which obtain burst and determination through its bridge-shaped foot supporting the framework. The hammer seat cushion is a modern development of timeless classical sofas.

Schmale, brückenförmige Aluminiumfüße, die die gesamte Struktur stützen, betonen die elegante und harmonische Form des Modells. Die L-förmigen Sitzkissen sind eine moderne Weiterentwicklung des klassischen Sofas.

# HAMPTON MEMORY

140

Divani - Poltrone

2011

VERZELLONI





141

Hampton Memory\_ divano 246 B con gonna\_ sofa 246 B with skirt\_ Sofa 246 B mit Volant





## LIEVORE ALTHERR MOLINA

Divano informale di design essenziale ed elegante, può essere utilizzato come divano normale o come ampia dormeuse, ideale per un uso a centro stanza in quanto utilizzabile da entrambi i lati.

Informal settee with a simple, elegant design, it can be used as a regular settee or as a comfortable sleeper, ideal to be placed in the middle of the room, as it can be used on both sides.

Legere Couch mit minimalistischem und elegantem Design, kann als normales Sofa oder als großzügige Dormeuse genutzt werden, ideal für die Stellung in der Mitte eines Zimmers, da sie von beiden Seiten benutzt werden kann.

# ITACA



145

Itaca\_ divano 267 DX\_ sofa 267 DX\_ Sofa 267 DX



Itaca\_ divano 267 DX\_ sofa 267 DX\_ Sofa 267 DX



Itaca\_ divano 267 SX, elemento 125 e pouf 125  
sofa 267 SX, element 125 and pouf 125\_ Sofa 267 SX, Element 125 und Hocker 125

LIEVORE ALTHERR MOLINA

La collezione Noe è un sistema che comprende divani così come numerosi elementi componibili, angoli, laterali, chaise longue e vari pouf, i quali, abbinati a piacere, offrono innumerevoli combinazioni.

The Noe collection is a system that includes sofas as well as numerous sectional elements, corners, side elements, chaise lounge and various poufs, which, combined as desired, offer innumerable combinations.

Die Kollektion Noe ist ein System aus Sofas und zahlreichen Elementen: Eckteile, Seitenteile, Chaiselongues und verschiedene Hocker, die nach eigenem Geschmack kombiniert werden können.

# NOE























Noe Punto Cavallo\_ Si tratta di un'impuntura decorativa disponibile in 11 colori da abbinare a piacere al tessuto scelto.  
Il tessuto è da selezionare fra quelli idonei.

Noe Punto Cavallo\_ Decorative stitching available in 11 colours to be matched at pleasure with the fabric.  
Fabric has to be chosen among those specified as suitable.

Noe Punto Cavallo\_ Ziernaht, die in 11 Farben erhältlich ist, kann mit den dafür geeigneten Stoffen,  
je nach Wunsch, kombiniert werden.



Cucitura Punto Cavallo\_ stitching Punto Cavallo\_ Zierstich Punto Cavallo

Noe Punto Cavallo\_ laterale 100 SX e laterale 100 DX  
side piece 100 SX and side piece 100 DX\_ Seitenteil 100 SX und Seitenteil 100 DX



È OBBLIGATORIO USARE  
OCCHIALI O SCHERMI



## LIEVORE ALTHERR MOLINA

Joe è un sistema di moduli con speciali caratteristiche di componibilità, disponibile in due altezze di schienale: versione Alta composta da 10 elementi di diverse profondità e larghezze e versione Bassa composta da 10 elementi.

Joe is a module system with special modularity features. Joe is available in two backrest heights: High version consisting of ten items of various depths and widths, and Low version consisting of ten items.

Joe ist ein System von Modulen mit speziellen Charakteristika zur Zusammenstellung, erhältlich mit einer Rückenlehne in zwei Höhen: eine höhere Variante bestehend jeweils aus 10 Elementen unterschiedlicher Tiefe und Breite und eine niedrigere Variante, bestehend aus 10 Elementen.

# JOE



Joe Alto\_ elemento 135 A XL, chaise longue 102 e pouf 102x135  
element 135 A XL, chaise longue 102 and pouf 102x135\_ Element 135 A XL, Chaiselongue 102 und Hocker 102x135  
Jim\_ tavolino\_ small table\_ Beistelltisch















Joe Basso\_ laterale 112 B SX, elementi 102 B e pouf 88x102  
side piece 112 B SX, elements 102 B and pouf 88x102\_ Seitenteil 112 B SX, Elemente 102 B und Hocker 88x102  
Jules\_ tavolino\_ small table\_ Beistelltisch



## CRD VERZELLONI

Linea essenziale, elegante e molto confortevole offre un ventaglio di divani ed elementi accostabili che, abbinati liberamente, creano infinite possibilità di combinazioni grazie ai 138 moduli a disposizione.

Minimalist, elegant and extremely comfortable settees and elements that combine freely in an infinite number of possibilities thanks to the 138 modules available.

Nüchternes Design, elegant und sehr komfortabel. Durch ein breites Spektrum an Sofas und kombinierbaren Elementen, bietet es durch die 138 Module eine Unzahl an Möglichkeiten zur freien Gestaltung.

# LINK













Link\_ dormeuse 238 XL SX B, laterale 231 DX A e pouf 136  
dormeuse 238 XL SX B, side piece 231 DX A and pouf 136\_ Dormeuse 238 XL SX B, Seitenteil 231 DX A und Hocker 136



178

Link Classic\_ divano 304 XL B con gonna  
sofa 304 XL B with skirt\_ Sofa 304 XL B mit Volant





LIEVORE ALTHERR MOLINA

Elliot è un programma di imbottiti studiato per offrire il massimo comfort non solo ergonomico  
ma anche visivo.

Elliot is a range of upholstered furniture designed to offer maximum comfort, not only ergonomically,  
but also visually.

Elliot ist ein Polstermöbelprogramm, das entwickelt wurde, um maximalen ergonomischen  
und sichtbaren Komfort zu erreichen.

# ELLIOT













185

Elliot\_ chaise longue 125 SX, elemento 98 e laterale 125 DX  
chaise longue 125 SX, element 98 and side piece 125 DX\_ Chaiselongue 125 SX, Element 98 und Seitenteil 125 DX





187

Elliot\_ laterale 125 SX, elementi 98, angolo 99 e pouf 91  
side piece 125 SX, elements 98, corner 99 and pouf 91\_ Seitenteil 125 SX, Eckelement 98, Eckstick 99 und Hocker 91

LIEVORE ALTHERR MOLINA

Poltrona di design rigoroso, comoda ed adatta alla conversazione, progettata sia per un uso domestico che per un utilizzo contract: receptions, sale d'aspetto, camere d'albergo.

Armchair in a simple design, comfortable, and suitable for conversation, designed both to be used in the home and for intense contract use: reception rooms, waiting rooms, hotel rooms.

Sessel in rigorosem Design, bequem und zur Konversation geeignet, sowohl für den häuslichen als auch für den Objektbereich entwickelt Rezeptionen, Warteräume, Hotelzimmer.

# PATTY













CRD VERZELLONI

Rubik si distingue per la sua linea rigorosa, compatta, essenziale ed elegante; offre un'ampia gamma di divani, di elementi laterali e angolari per un totale di 37 moduli con diverse funzioni, i quali liberamente abbinati, sono in grado di assicurare innumerevoli combinazioni.

Rubik distinguishes itself thanks to its rigorous, compact, essential and elegant lines: It has a wide range of modular sofas, corner and lateral elements for a total of 37 modular units with different functions, which, freely combined, allow countless combinations to be obtained.

Rubik ist durch geometrische, kompakte, essentielle, elegante Linien gekennzeichnet. Die Kollektion bietet eine große Auswahl an Sofas, Eck- und Seitenelementen - insgesamt 37 Elemente, die verschiedene Funktionen haben und untereinander kombiniert werden können, um unendliche Zusammenstellungen zu schaffen.

# RUBIK









Rubik\_ laterale 219 SX, chaise longue 121 DX e pouf 120  
side piece 219 SX, chaise longue 121 DX and pouf 120\_ Seitenteil 219 SX, Chaiselongue 121 DX und Hocker 120



## LIEVORE ALTHERR MOLINA

Poltrona girevole fornita sia in versione alta, con poggiatesta regolabile a varie altezze, che in versione bassa.  
La versione alta consente di raggiungere il massimo comfort soprattutto se abbinata al pouf sempre girevole.  
La versione bassa è adatta alla conversazione.

Swivel armchair with high version, with headrest adjustable in different heights, or with low version.  
The high version reaches maximum comfort especially if used together with the pouf, which is swivel as well.  
The low model is suitable for sitting and chatting.

Drehbarer Sessel, lieferbar in Variante "Sillon Alto", d.h. mit höhenverstellbarer Kopfstütze und in Variante "Sillon Basso"  
d.h. ohne Kopfstütze. Die Ausführung "Alto" ermöglicht ein Höchstmaß an Komfort, besonders in Zusammenhang  
mit dem drehbaren Hocker. Die Ausführung "Basso" ist zur Konversation geeignet.

# SILLÓN







Sillón\_ poltrone basse\_ armchairs low version\_ niedrige Sessel

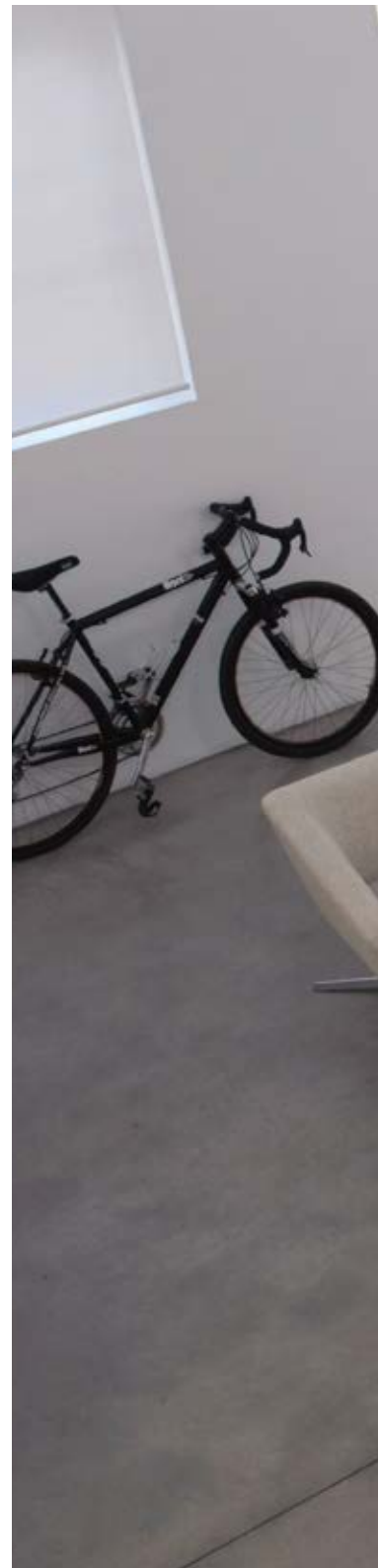





## LIEVORE ALTHERR MOLINA

Collezione composta dalla poltrona, adatta alla conversazione, progettata sia per un uso domestico che per un utilizzo contract: receptions, sale d'aspetto, camere d'albergo, e dalla sedia, adatta per tavolo da pranzo o tavolo riunione.

The collection consists of an armchair, suitable for conversation, designed both to be used in the home and for intense contract use: reception rooms, waiting rooms, hotel rooms, and a chair for the dining table or meeting table.

Die Kollektion besteht aus einem bequemen und große Ruhe ausstrahlenden Sessel, der sich sowohl für den privaten Gebrauch wie auch für den Objektbereich eignet, wie z.B für Empfangs- und Warteräume oder Hotelzimmer. Der dazu passende Stuhl, findet seinen Einsatz im Ess- und Besprechungsbereich.

# KELLY











Kelly\_ sedie\_ chairs\_ Stühle







LIEVORE ALTHERR MOLINA

Collezione composta dalla poltrona, adatta alla conversazione e dalla sedia adatta per il tavolo da pranzo o il tavolo da riunione.

The collection consists of an armchair for sitting and chatting and a chair for the dining table or meeting table.

Kollektion bestehend aus einem Konversationsessel und aus einem Stuhl, passend sowohl an einen Ess- als auch an einen Konferenztisch.

# CUBICA



Cubica\_ poltrone girevoli con base fusione alluminio verniciato antracite  
armchairs with swivel base in painted aluminium cast – dark grey\_ Drehsessel mit Fußgestell in poliertem Aluminiumguss

Cubica\_ poltrone girevoli con base fusione alluminio lucidato  
armchairs with swivel base in polished aluminium cast\_ drehbare Sessel mit polierter Aluminiumguss









LIEVORE ALTHERR MOLINA

Linea essenziale. Offre un'elevata comodità nonostante le dimensioni ridotte.

Essential line. It offers a high level of comfort despite the reduced dimensions.

Einfache Linie, trotz der geringen Abmessungen optimale Bequemlichkeit.

# CALVINO

Poltrone

1992

VERZELLONI









CRD VERZELLONI

Collezione di tavolini disponibili in due misure di diametro e tre altezze accostabili e sovrapponibili.

Coffee tables available in two diameters and in three different, approachable and overlapping heights.

Beistelltische in zwei unterschiedlichen Durchmesser und drei Höhen, kombinier- und überlappend aufstellbar.

# ROBIN



CRD VERZELLONI

Grazie al design essenziale, sono adatti sia agli ambienti residenziali che a quelli pubblici come ad esempio le lounges degli alberghi o le sale d'attesa. I pouf Planet rappresentano delle comode sedute e dei validi piani di appoggio.

Thanks to its essential design it is suitable to be used both for residential as well as public areas, such as hotel lounges or waiting rooms. Planet offers a comfortable seat and can be used as a valid support surface.

Dank ihres essentiellen Designs eignen sie sich sowohl für Wohnbereiche als auch für öffentliche Bereiche wie Hotellounges oder Wartezimmer. Planet Hocker dienen als bequeme Sitz- und nützliche Auflageflächen.

# PLANET



## CRD VERZELLONI

Tavolino dal design lineare e funzionale con piano in marmo; disponibile rotondo o quadrato.  
Adatto ad ambienti residenziali così come ad aree lounge e raffinati progetti contract.

Coffee table with a linear and functional design with marble top; available round or square.  
Suitable for residential environments as well as for lounge areas and refined contract projects.

Couchtisch mit einem linearen und funktionellen Design mit Marmorplatte; verfügbar in rund oder quadratisch.  
Geeignet sowohl für Wohn- als auch für Lounch Bereiche und raffinierte Vertragsprojekte.

# ANTERO





Antero\_ tavolino Ø 115 e tavolino 110  
coffee table Ø 115 and coffee table 110\_ Couchtisch Ø 115 und Couchtisch 110

SIMON MORASI PIPERČIĆ

Con la sua leggerezza Etan sa conquistare chi desidera completare con grazia i propri spazi.  
Le sue linee verticali, una opposta all'altra, creano un gioco visivo che mostra il carattere distintivo della libreria.  
È stata disegnata con una dolce raggatura che le conferisce un aspetto accogliente e friendly.

With its lightness Etan knows how to conquer those who want to gracefully complete their spaces.  
Its vertical lines, one opposite to the other, create a visual game that shows the distinctive character of the bookcase.  
It has been designed with a soft rounding that gives it a welcoming and friendly appearance.

Etan erobert durch seine Leichtigkeit diejenigen, die ihre Räume mit zierlichen Möbeln ausstatten möchten.  
Seine vertikalen Linien, eine gegenüber der anderen, schaffen ein visuelles Spiel, das den unverwechselbaren Charakter  
des Bücherregals zeigt. Die weichen Rundungen verleihen ihm ein ansprechendes und friendly Aussehen.

ETAN



231

Etan\_ libreria bassa\_ bookcase low\_ Bücherregal niedrig





LIEVORE ALTHERR MOLINA

Pratici piani di appoggio dalle linee decise e minimali incontrano un materiale caldo come il legno.

Practical support surfaces with strong and minimal lines meet a warm material such as wood.

Praktische Abstellflächen mit strengen und minimalen Linien treffen auf ein warmes Material wie Holz.

# JIM JULES

234

Tavolini

2010

VERZELLONI



CRD VERZELLONI

Serie di tavolini di 3 misure e altezze diverse accostabili e sovrapponibili.

Series of 3 coffee tables of different sizes and heights matched and overlapping.

Serie von 3 Beistelltischen verschiedener Größen und Höhen, aufeinander abgestimmt und überlappend aufstellbar.

# CLUB







Club\_ rigenerato di fibre di cuoio color testa di moro\_ Regenerated leather fibre - dark brown\_ Bonded Leder - dunkelbraun



LIEVORE ALTHERR MOLINA

Argo, grazie al particolare disegno della base, è un tavolino idoneo ad essere affiancato ai modelli Elliot, Hampton, Hampton Memory, Holden, Itaca, Larsen, Link, Noe, Rubik e Zoe, offrendo un piano di appoggio pratico e funzionale.

The particular design of its base makes Argo an ideal match to models Elliot, Hampton, Hampton Memory, Holden, Itaca, Larsen, Link, Noe, Rubik and Zoe. Indeed, this small table serves as a practical and functional rest top.

Dank des speziellen Designs seines Gestells, ist Argo ein idealer Beistelltisch passend zu den Modellen Elliot, Hampton, Hampton Memory, Holden, Itaca, Larsen, Link, Noe, Rubik und Zoe, der eine praktische und zweckmäßige Ablagefläche bietet.

# ARGO



241

Argo\_ tavolino\_ small table\_ Beistelltisch

Qualità Globale - Fatto in Italia

Globale Qualität - Hergestellt in Italien

# GLOBAL QUALITY

Grazie alla filiera produttiva completamente ed esclusivamente italiana, ogni prodotto Verzelloni può avvalersi del marchio "Made in Italy". A conferma di questa dichiarazione Verzelloni ha realizzato il "Decalogo della Qualità Globale".

All'interno del Decalogo sono descritti i principi della qualità che caratterizzano ogni fase del processo produttivo, dalla progettazione alla selezione delle materie prime, fino all'accurata lavorazione, in coerenza con le rigorose procedure interne che derivano da un know-how maturato in oltre 70 anni di attività. Ogni articolo viene corredato da una Scheda Prodotto all'interno della quale sono riportati i dati tecnici e di costruzione, informazioni generali per una buona manutenzione così come lo spaccato tecnico dove sono descritti i materiali utilizzati per realizzare ogni singolo prodotto. Dove necessario, vengono unite le istruzioni complete di immagini relative al montaggio e alla corretta procedura per sfoderare e rivestire il modello acquistato. Allegato alla Scheda Prodotto viene consegnato un campione del rivestimento utilizzato insieme ad un'etichetta su cui vengono riportati la composizione del tessuto, le istruzioni per la manutenzione e il lavaggio ed eventuali informazioni aggiuntive relative alle caratteristiche principali dello stesso.



Through its entirely and exclusive Italian production chain, each product manufactured by Verzelloni is rightly entitled to receive the "Made in Italy" label. To reinforce this statement, Verzelloni has printed a "Global Quality Handbook". Included within the content, Verzelloni describes the main principles of quality distinguishing each step of the production process, from the design stage, to the selection of raw materials, the crafted workmanship, all in accordance with the rigorous internal procedures, the result of over 70 years experience. Every item is provided with a "Product Sheet", complete with general technical and manufacturing data, information for good maintenance, as well as detailed technical specification and materials used for the manufacturing of each specific product range. Where necessary, instructions and images are provided, showing the right assembly procedure and how to remove or put on the main cover. A sample of the fabric used is also attached to the Product Sheet, with a label showing fabric composition, washing and maintenance instruction with any additional information about the main fabric features.



Dank ein gänzlich italienischen Fertigungskette kann jedes Verzelloni-Produkt mit dem Markenzeichen "Made in Italy" ausgezeichnet werden. Zur Bestätigung dieser Aussage hat Verzelloni den „Leitfaden der Globalen Qualität“ realisiert. Der Leitfaden beschreibt die Qualitätsprinzipien, die jede Phase des Produktionsprozesses charakterisiert, d.h. vom Entwurf über die Auswahl der Rohmaterialien bis hin zur akkuraten Verarbeitung. Dies geschieht im Einklang mit einer strengen internen Prozedur, die auf ein in über 70 Jahre Aktivität erworbenes know-how zurückzuführen ist. Ein Produktblatt mit allen technischen und Herstellungsdaten, allgemeinen Wartungsinformationen sowie einer Datailabbildung, in der die Materialien beschrieben sind, die für jedes einzelne Produkt verwendet werden, bestätigt diese Aussage. Wo notwendig, werden Anleitungen mit Abbildungen für die Montage und die korrekten Arbeitsschritte für das Abziehen und Neuabziehen des erworbenen Modells beigelegt. Dem Produktblatt liegt ein Muster des verwendeten Bezugstoffes bei, zusammen mit einem Etikett, auf dem die Zusammensetzung des Stoffes, die Wartungs- und Reinigungsanweisungen sowie eventuelle zusätzliche Informationen über dessen Haupteigenschaften angegeben sind.

Informazioni Tecniche

Technische Information

# TECHNICAL INFO

244



VERZELLONI



Indice

Index

Davos 246

Lyndon 248

Emily 256

Holden 257

Zoe 265

Zoe More 267

Nilson 269

Nilson Lounge 273

Irving 274

Larsen 282

Divanitas 286

Fold 287

Hampton 290

Hampton Memory 296

Itaca 298

Noe 299

Joe 301

Link 304

Elliot 310

Patty 312

Rubik 313

Sillón 315

Kelly 316

Cubica 317

Calvino 318

Robin 319

Planet 320

Antero 321

Etan 322

Jim e Jules 323

Club 324

Argo 325





**Caratteristiche:** Davos è una collezione dalla linea arrotondata e dal design elegante e rigoroso, caratterizzata da un'elevata comodità grazie all'altezza dello schienale. Davos è disponibile in 4 misure di divani e due pouf. I divani comprendono due poggiatesta decorativi ed ergonomici che, se confezionati nello stesso rivestimento e colore del divano, sono inclusi nel prezzo. Se si desiderano i due poggiatesta in un rivestimento o colore differente dal divano occorre considerare un supplemento come indicato nel listino. Davos può essere corredato anche da cuscinetti in piuma 100% di diverse misure. Il rivestimento, ad eccezione della versione in pelle, è completamente sfoderabile. **Struttura-Imbottitura:** Fusto in legno multistrato, imbottito in poliuretano espanso indeformabile a densità differenziata, molleggio con nastri elastici intrecciati. Prerivestimento con velfodera accoppiata con fibra poliestere. Di serie il piede è cilindrico in alluminio alto cm.4 verniciato color bronzo oppure, su richiesta e senza supplemento, verniciato di colore nero. In alternativa, su richiesta e senza supplemento, alto cm. 6 verniciato color bronzo oppure verniciato di colore nero.

**Features:** Davos collection has a rounded line and an elegant and rigorous design, it offers high comfort thanks to the height of its backrest. Davos range includes four sofas and two poufs. Sofas include two decorative and ergonomic lumbar cushions, which are included in the price when covered in the same upholstery and colour of the sofa. If you want the two lumbar cushions in a different upholstery or colour from the sofa an upcharge needs to be considered. Davos can be equipped with decorative cushions 100% feathers in different sizes. The fabric cover, with the exception of the leather version, is completely removable.

**Framework-Padding:** Frame in plywood padded with non-deformable polyurethane with different densities, springs with interwoven elastic bands. Lining in Velfodera coupled with polyester fibre. Standard feet are cylindrical in bronze painted aluminium cast, height 4 cm, upon request and without upcharge, they are available black painted too. As an alternative upon request only and without upcharge, they are available 6 cm height either in bronze or black painted aluminium cast.

**Eigenschaften:** Davos ist eine Kollektion mit Rundungen und einem eleganten und strengen Design, das sich, dank der Höhe der Rückenlehne, durch hohen Komfort auszeichnet. Davos ist in 4 Sofa- und zwei Hockergrößen erhältlich. Die Sofas beinhalten zwei dekorative und ergonomische Lendenkissen, die, wenn sie mit demselben Stoff und derselben Farbe wie das Sofa konfektioniert werden, im Preis inbegriffen sind. Werden die beiden Lendenkissen in einem anderen Bezug oder einer anderen Farbe als das Sofa gewünscht, ist ein Aufpreis (siehe Preisliste) zu berücksichtigen. Davos kann auch mit 100% Federkissen unterschiedlicher Größe ausgestattet werden. Der Bezug ist, mit Ausnahme der Lederversion, komplett abnehmbar. **Struktur-Polsterung:** Korpus aus Sperrholz, gepolstert mit formstabilem Polyurethan unterschiedlicher Dichte, Federung mit geflochtenen elastischen Gurten. Schonbezug mit Velfodera gekoppelt mit Polyesterfaser. Die Standardfüße sind zylindrisch, aus bronzefarben lackiertem Aluminium, 4 cm hoch oder, auf Anfrage, schwarz lackiert. Ebenfalls auf Anfrage und ohne Aufpreis sind diese Fußvarianten auch in einer Höhe von 6 cm erhältlich.

#### PIEDE FOOT FUSS

Cilindrico alluminio verniciato color bronzo o nero su richiesta.  
Cylindrical bronzed or upon request black painted aluminum.  
Aluminium zylindrisch, lackiert in Bronze oder Schwarz auf Anfrage.

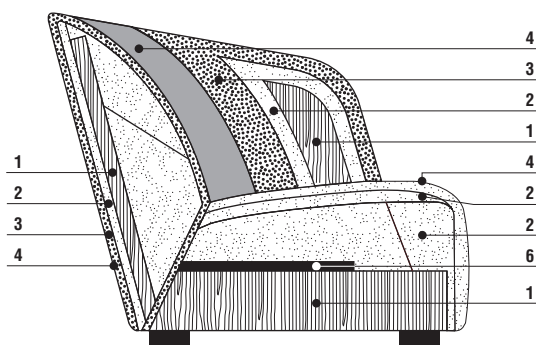

#### SEZIONE SECTION SEKTION

- 1: Fusto in legno massello e multistrato.  
Frame in solid wood and plywood.  
Korpus aus Massivholz, und schichtverleimt.
- 2: Poliuretano a densità differenziata.  
Differentiated density polyurethane.  
Polyurethan unterschiedlicher Dichte.
- 3: Fibra poliestere. Polyester Fibre.  
Polyesterfaser.
- 4: Velfodera. Velfodera.  
Velfodera.
- 5: Poliuretano. Polyurethane. Polyurethan.
- 6: Nastri elastici. Elastic belts. Elastische Gurte.

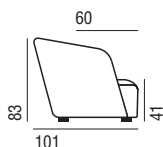

FIANCO

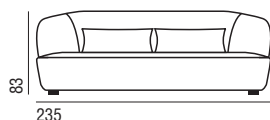

FRONTE

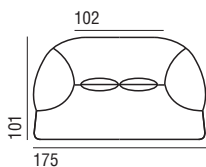

DIVANO 175

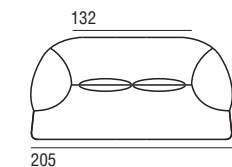

DIVANO 205

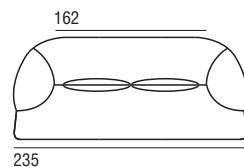

DIVANO 235

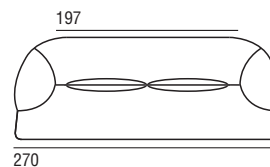

DIVANO 270

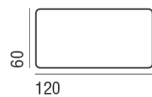
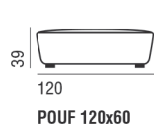
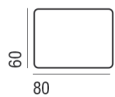
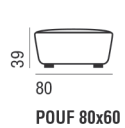

---

**CUSCINI 100% PIUMA**

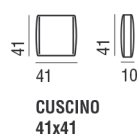
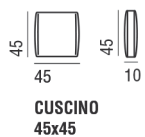

---

**CUSCINI POGGIARENI 100% PIUMA**





**Caratteristiche:** Linea classica e contemporanea, lussuosa ed elegante, Lyndon è caratterizzato da un morbido e accogliente bracciolo e da un cuscino di seduta dallo spessore elevato in contrapposizione con la base sottile che conferisce leggerezza alla struttura. Lyndon è un sistema di sedute composto da diversi moduli lineari e alcuni dalla forma arrotondata che ne arricchiscono le possibilità estetiche e di design. E' disponibile in un'ampia gamma di divani, elementi, laterali, angoli, chaise longue, dormeuse, terminali e pouf che possono essere abbinati a piacere e permettono di creare innumerevoli combinazioni grazie al bracciolo perfettamente accostabile allo schienale. Lyndon si può scegliere tra due differenti versioni: Standard, completa di Cuscini-Schienale in piuma con inserto in poliuretano, e Base (senza Cuscini-Schienale). La versione Base è da completare con i cuscini-schienale disponibili in collezione: alcuni strutturati in piuma con inserto in poliuretano, altri in piuma 100% canalizzata entrambi coordinabili fra loro a piacimento. Il rivestimento, ad eccezione della versione in pelle, è completamente sfoderabile. **Struttura:** Fusto in legno massello e multistrato, imbottito in poliuretano espanso indeformabile a densità differenziata, molleggio con nastri elastici intrecciati. Prerivestimento con tela di cotone accoppiata con fibra poliestere. Il piede standard è in fusione di alluminio verniciato color bronzo alto cm.4. Su richiesta è disponibile un piede cilindrico in alluminio verniciato color bronzo altezza cm.4 oppure cm.6. **Imbottiture cuscini:** Cuscini-Schienale: alcuni strutturati in piuma canalizzata con inserto in poliuretano, altri in piuma 100% canalizzata. I cuscini di seduta sono in poliuretano a densità differenziata e fibra poliestere. Tutte le imbottiture sono interamente prerivestite in tela bianca.

**Features:** Classic and contemporary line with a luxurious and elegant look, Lyndon is characterized by an armrest with a welcoming form and by a high thickness seat cushion, supported by a thin base that gives lightness. Lyndon is a seating system composed of several linear modules, some with a rounded shape that enrich the aesthetic and design possibilities. It is available in a wide range of sofas, elements, side elements, corners, chaise longue, ottomans, terminals and poufs that can be combined as desired and allow to create countless combinations thanks to the armrest that can be perfectly placed against the back. Lyndon offers the possibility of choosing between two versions: the standard version, complete with feather back cushions with polyurethane insert and the base version (without back cushions). The base version can be integrated with the back cushions available in the collection: some structured in feathers with a polyurethane insert, others 100% canalized feathers, both can be coordinated with each other at will. The fabric cover, with the exception of the leather version, is completely removable. **Structure:** Frame in solid and plywood, padded with non-deformable polyurethane foam of different densities, springs with interwoven elastic bands. Pre-cover in cotton fabric coupled with polyester fiber. The standard foot is in cast aluminium painted bronze color high cm. 4. On request, a cylindrical foot in bronze painted aluminium with a height of cm 4 or cm 6 is also available. **Cushion padding:** Backrest cushions: some available in canalized feathers with polyurethane insert others padded with 100% canalized feathers. Seat cushions are in differentiated density polyurethane and polyester fiber. All the paddings are entirely pre-covered in white fabric.

**Eigenschaften:** Klassisch und modern, luxuriös und elegant. Lyndon zeichnet sich durch eine weiche und bequeme Armlehne und durch ein hohes Sitzkissen aus, im Gegensatz zu der schmalen Linie der Basis, die der Struktur Leichtigkeit verleiht. Lyndon ist ein Sitzsystem, das aus mehreren linearen Modulen und einigen mit abgerundeten Formen besteht, die die ästhetischen und gestalterischen Möglichkeiten bereichern. Es ist in einer großen Auswahl an Sofas, Elementen, Seitenteilen, Ekelementen, Chaiselongue, Dormeuse, Endelementen und Hocker erhältlich, die beliebig kombiniert werden können. Dank der perfekt auf den Rücken abgestimmten Armlehne ermöglicht es unzählige Kombinationen. Lyndon ist in zwei verschiedenen Ausführungen erhältlich: Standard, d. h. komplett mit Rückenkissen aus Federn mit Polyurethaneinlage oder Basis (ohne Rückenkissen). Die Basisvariante wird mit den in der Kollektion verfügbaren Rückenkissen vervollständigt: Einige sind strukturiert mit Federn und Polyurethaneinlage, andere 100% Federn. Beide können nach Belieben aufeinander abgestimmt werden. Der Bezug ist, mit Ausnahme der Lederversion, vollständig abziehbar. **Struktur:** Gestell aus Massiv- und Mehrschichtholz, gepolstert mit formstabilem Polyurethan unterschiedlicher Dichte, Federung mit geflochtenen elastischen Gurten. Schonbezug aus Baumwollstoff, gekoppelt mit Polyesterfaser. Der Standardfuß ist aus Aluminiumguss, 4 cm hoch, bronzenfarben lackiert. Auf Anfrage ist ein zylindrischer Fuß aus bronzenfarben lackiertem Aluminium erhältlich, Höhe 4 cm oder 6 cm. **Kissenpolsterung:** Rückenkissen: einige mit in Kammern gesteppten Federn und Polyurethaneinlage, andere in 100% Federn, in Kammern gesteppt. Die Sitzkissen sind aus Polyurethan unterschiedlicher Dichte und Polyesterfaser. Alle Polster sind mit einem weißen Schonbezug verkleidet.

#### PIEDE FOOT FUSS - STANDARD

Fusione di alluminio verniciato color bronzo.  
Bronzed painted aluminium cast.  
Bronzefarbener Aluminiumguss.

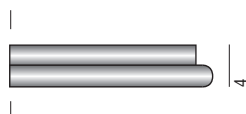

#### PIEDE FOOT FUSS - OPTIONAL

Cilindrico alluminio verniciato color bronzo.  
Cylindrical bronzed painted aluminium.  
Zylindrisch bronzefarbenes Aluminium.

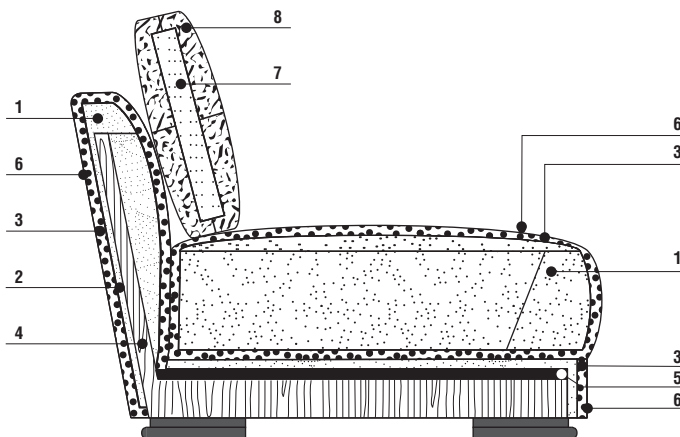
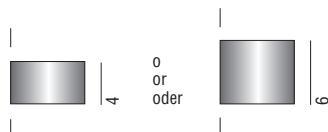

#### SEZIONE SECTION SEKTION

- 1: Poliuretano a densità differenziata.  
Differentiated density polyurethane.  
Polyurethan unterschiedlicher Dichte.
- 2: Poliuretano. Polyurethane. Polyurethan.
- 3: Fibra poliestere. Polyester Fibre.  
Polyesterfaser.
- 4: Fusto in legno massello e multistrato.  
Frame in solid wood and plywood.  
Korpus aus Massivholz, und schichtverleimt.
- 5: Nastri elastici. Elastic belts. Elastische Gurte.
- 6: Fodera in tela. Fabric lining. Schonbezug.
- 7: Inserto in Poliuretano. Polyurethane insert.  
Kern aus Polyurethan.
- 8: Piuma. Feather. Federfüllung.

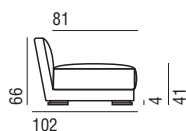

FIANCO VERSIONE BASE



FRONTE VERSIONE BASE

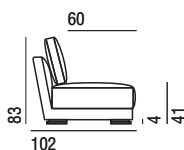

FIANCO VERSIONE STANDARD

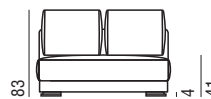

FRONTE VERSIONE STANDARD

**LYNDON VERSIONE BASE**



134

**ELEMENTO 134 BASE**



102

165

**ELEMENTO 165 BASE**

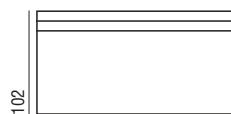

102

196

**ELEMENTO 196 BASE**

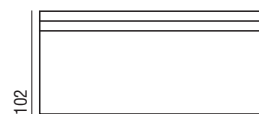

102

224

**ELEMENTO 224 BASE**

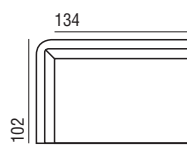

134

102

154

**LATERALE SX 154 BASE**

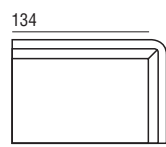

134

102

154

**LATERALE DX 154 BASE**

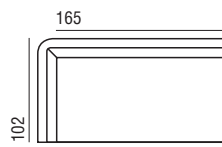

165

102

185

**LATERALE SX 185 BASE**

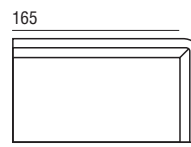

165

102

185

**LATERALE DX 185 BASE**

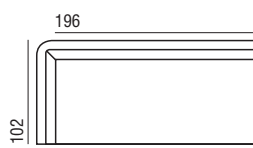

196

102

216

**LATERALE SX 216 BASE**

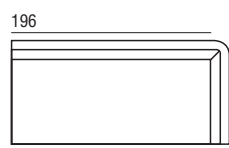

196

102

216

**LATERALE DX 216 BASE**

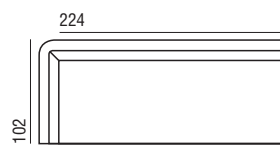

224

102

244

**LATERALE SX 244 BASE**

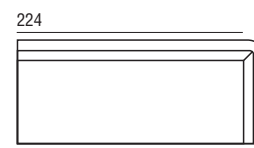

224

102

244

**LATERALE DX 244 BASE**

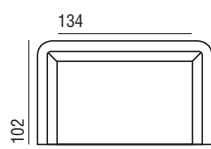

134

102

174

**DIVANO 174 BASE**

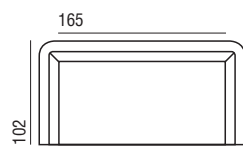

165

102

205

**DIVANO 205 BASE**

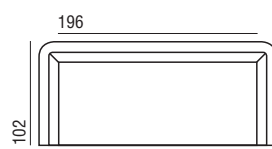

196

102

236

**DIVANO 236 BASE**

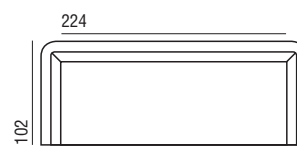

224

102

264

**DIVANO 264 BASE**

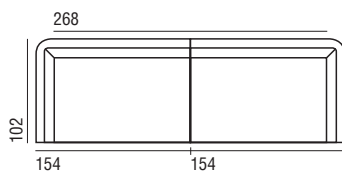

268

102

154

154

308

**DIVANO 308 BASE**

COMPOSTO DA  
1 LATERALE 154 SX  
E DA 1 LATERALE 154 DX

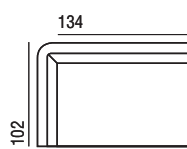

134

102

154

**ANGOLO SX 154 BASE**

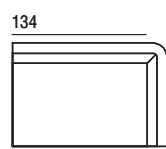

134

102

154

**ANGOLO DX 154 BASE**

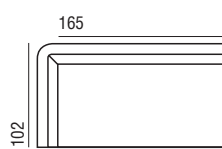

165

102

185

**ANGOLO SX 185 BASE**

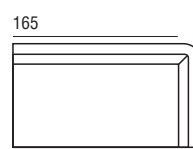

165

102

185

**ANGOLO DX 185 BASE**

**LYNDON VERSIONE BASE**

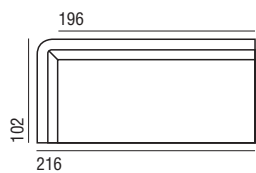

**ANGOLO SX 216 BASE**

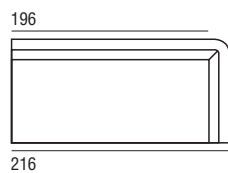

**ANGOLO DX 216 BASE**

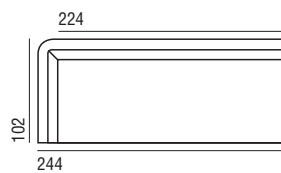

**ANGOLO SX 244 BASE**

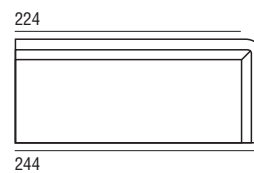

**ANGOLO DX 244 BASE**

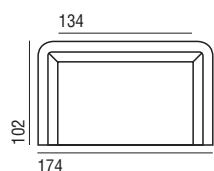

**ANGOLO LATERALE SX 174 BASE**

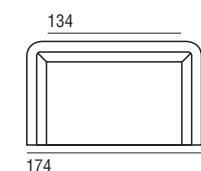

**ANGOLO LATERALE DX 174 BASE**

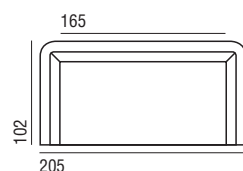

**ANGOLO LATERALE SX 205 BASE**

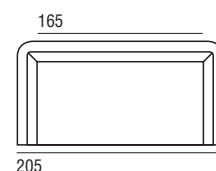

**ANGOLO LATERALE DX 205 BASE**

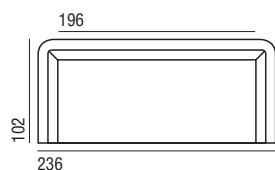

**ANGOLO LATERALE SX 236 BASE**

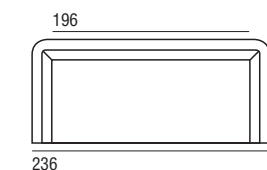

**ANGOLO LATERALE DX 236 BASE**

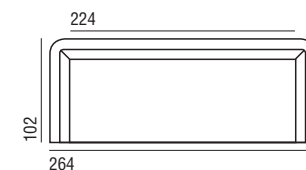

**ANGOLO LATERALE SX 264 BASE**

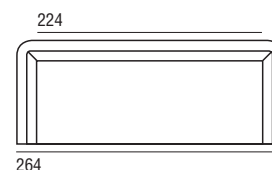

**ANGOLO LATERALE DX 264 BASE**

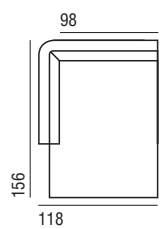

**CHAISE LONGUE SX 118 BASE**

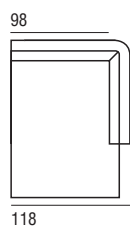

**CHAISE LONGUE DX 118 BASE**

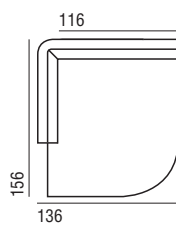

**CHAISE LONGUE SX 136 BASE**

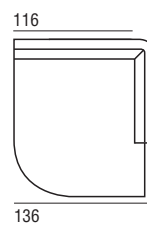

**CHAISE LONGUE DX 136 BASE**

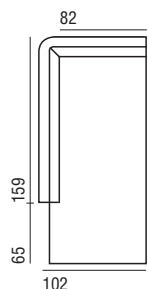

**DORMEUSE ANGOLO SX 224 BASE**

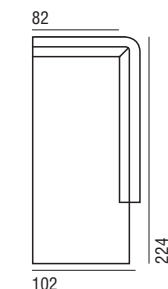

**DORMEUSE ANGOLO DX 224 BASE**

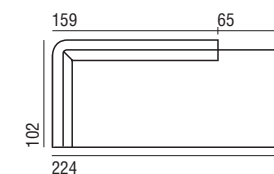

**DORMEUSE SX 224 BASE**

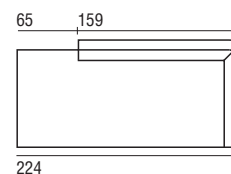

**DORMEUSE DX 224 BASE**

**LYNDON VERSIONE BASE**

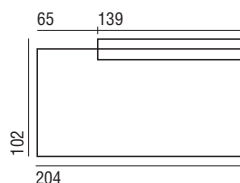

**TERMINALE SX 204 BASE**

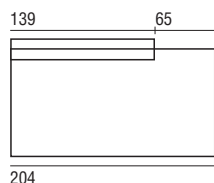

**TERMINALE DX 204 BASE**

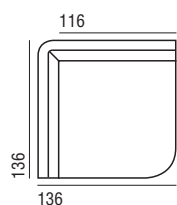

**ANGOLO 136 BASE**

**LYNDON VERSIONE STANDARD**

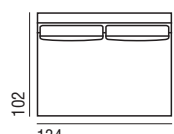

**ELEMENTO 134**

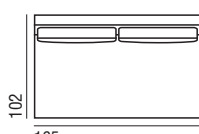

**ELEMENTO 165**

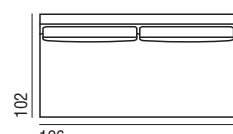

**ELEMENTO 196**

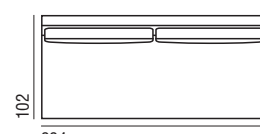

**ELEMENTO 224 2S**

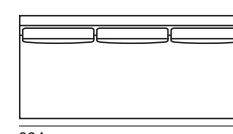

**ELEMENTO 224 3S**

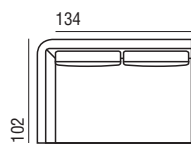

**LATERALE SX 154**

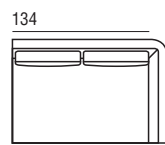

**LATERALE DX 154**

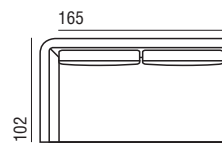

**LATERALE SX 185**

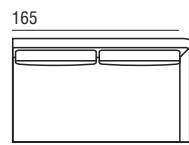

**LATERALE DX 185**

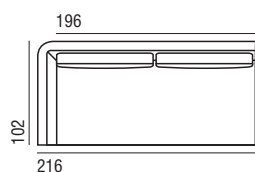

**LATERALE SX 216**

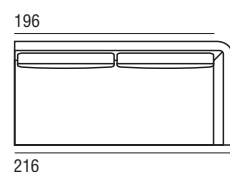

**LATERALE DX 216**

**LYNDON VERSIONE STANDARD**

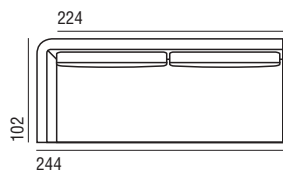

**LATERALE SX 244 2S**

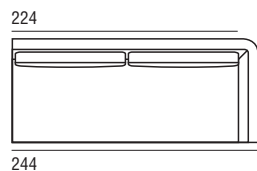

**LATERALE DX 244 2S**

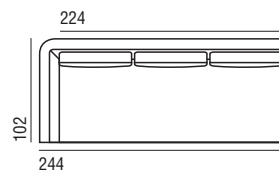

**LATERALE SX 244 3S**

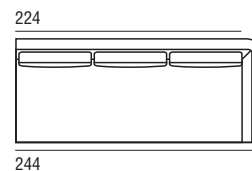

**LATERALE DX 244 3S**

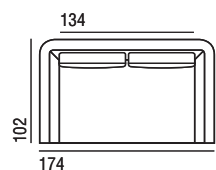

**DIVANO 174**

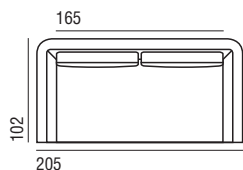

**DIVANO 205**

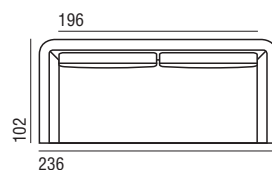

**DIVANO 236**

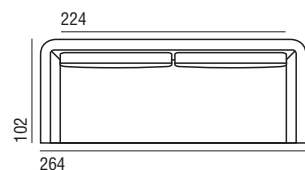

**DIVANO 264 2S**

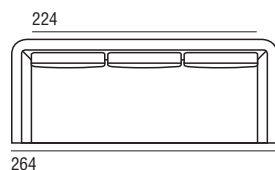

**DIVANO 264 3S**

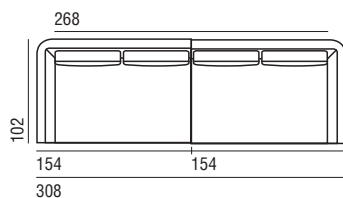

**DIVANO 308**

COMPOSTO DA  
1 LATERALE 154 SX  
E DA 1 LATERALE 154 DX

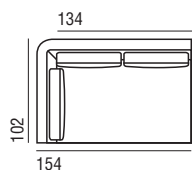

**ANGOLO SX 154**

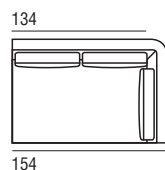

**ANGOLO DX 154**

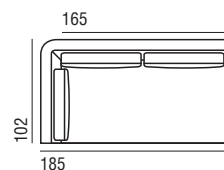

**ANGOLO SX 185**

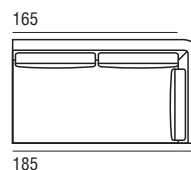

**ANGOLO DX 185**

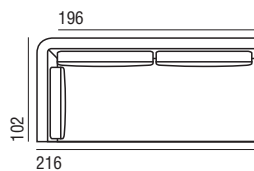

**ANGOLO SX 216**

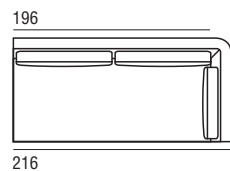

**ANGOLO DX 216**



**LYNDON VERSIONE STANDARD**

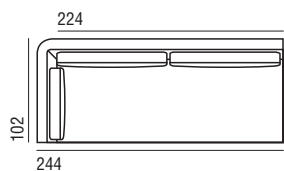

**ANGOLO SX 244 2S**

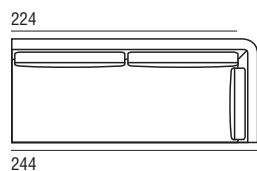

**ANGOLO DX 244 2S**

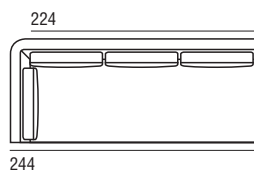

**ANGOLO SX 244 3S**

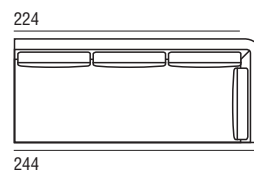

**ANGOLO DX 244 3S**

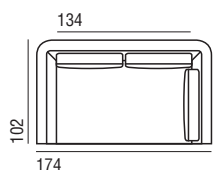

**ANGOLO LATERALE SX 174**

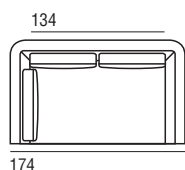

**ANGOLO LATERALE DX 174**

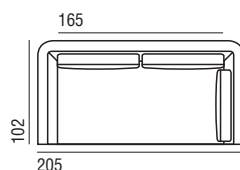

**ANGOLO LATERALE SX 205**

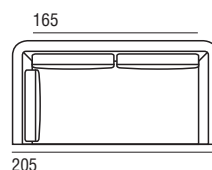

**ANGOLO LATERALE DX 205**

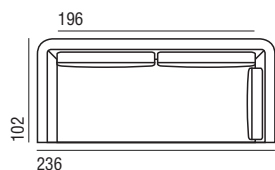

**ANGOLO LATERALE SX 236**

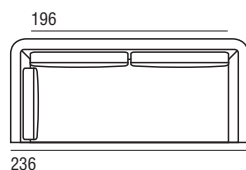

**ANGOLO LATERALE DX 236**

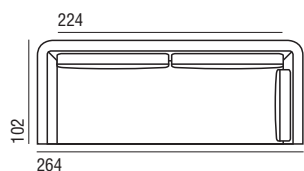

**ANGOLO LATERALE SX 264 2S**

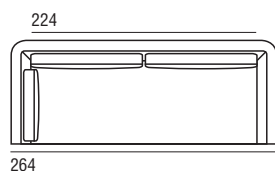

**ANGOLO LATERALE DX 264 2S**

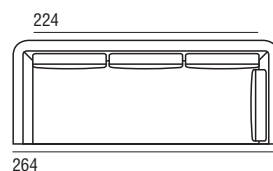

**ANGOLO LATERALE SX 264 3S**

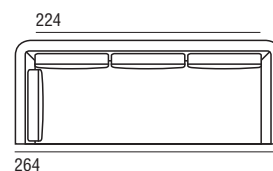

**ANGOLO LATERALE DX 264 3S**

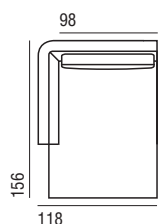

**CHAISE LONGUE SX 118**

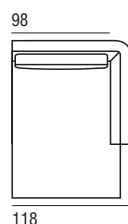

**CHAISE LONGUE DX 118**

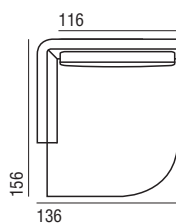

**CHAISE LONGUE SX 136**

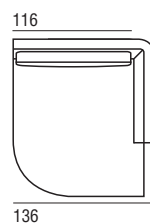

**CHAISE LONGUE DX 136**

LYNDON VERSIONE STANDARD

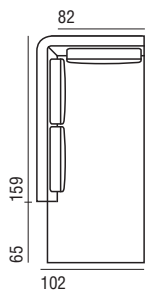

**DORMEUSE ANGOLO SX 224**

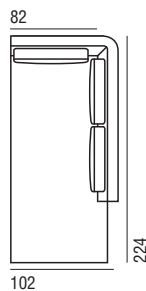

**DORMEUSE ANGOLO DX 224**

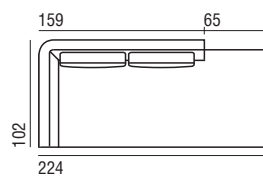

**DORMEUSE SX 224**

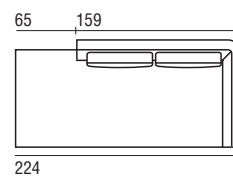

**DORMEUSE DX 224**

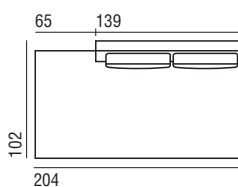

**TERMINALE SX 204**

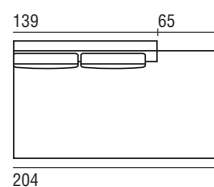

**TERMINALE DX 204**

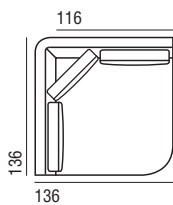

**ANGOLO 136**

**POSIZIONE LATERALE DEL POUF 91x91 - 91x70**

side view pouf 91x91 - 91x70  
Seitenansicht Position Hocker 91x91 - 91x70

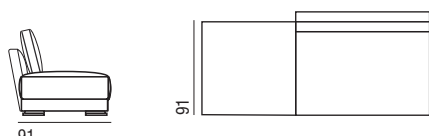

91

**FIANCO**

**PIANTA**

**POSIZIONE LATERALE DEL POUF 101x101 - 101x70**

side view pouf 101x101 - 101x70  
Seitenansicht Position Hocker 101x101 - 101x70

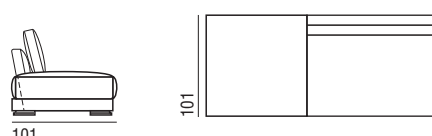

101

**FIANCO**

**PIANTA**

**POUF**

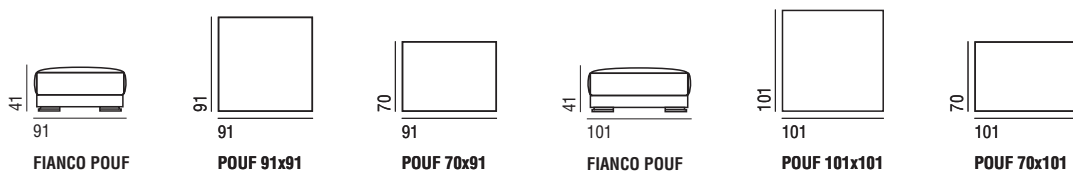

**FIANCO POUF**

**POUF 91x91**

**POUF 70x91**

**FIANCO POUF**

**POUF 101x101**

**POUF 70x101**

**CUSCINI SCHIENALI IN PIUMA CON INSERTO IN POLIURETANO**

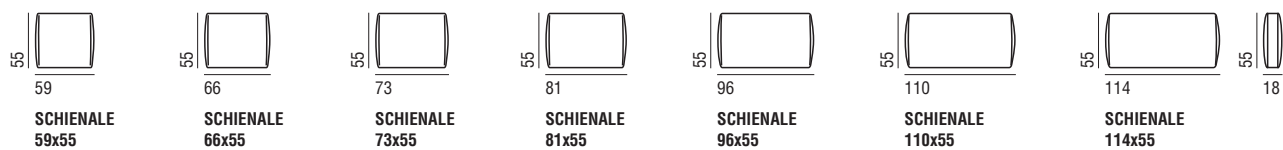

**SCHIENALE**  
59x55

**SCHIENALE**  
66x55

**SCHIENALE**  
73x55

**SCHIENALE**  
81x55

**SCHIENALE**  
96x55

**SCHIENALE**  
110x55

**SCHIENALE**  
114x55

**CUSCINI SCHIENALI 100% PIUMA**

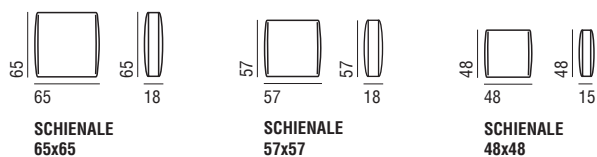

**SCHIENALE**  
65x65

**SCHIENALE**  
57x57

**SCHIENALE**  
48x48

**CUSCINI 100% PIUMA**

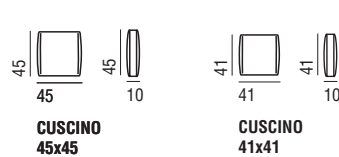

**CUSCINO**  
45x45

**CUSCINO**  
41x41

**CUSCINI POGGIARENI 100% PIUMA**



**CUSCINO**  
**POGGIARENI**  
86x25

**CUSCINO**  
**POGGIARENI**  
72x25

**CUSCINO**  
**POGGIARENI**  
56x25

**CUSCINO**  
**POGGIARENI**  
40x25

**CUSCINO**  
**POGGIARENI**  
54x33



**Caratteristiche:** Grazie alle dimensioni compatte e alla sua forma avvolgente ispirata a quella di una conchiglia, la poltrona Emily rappresenta il connubio ideale fra comodità ed eleganza per inserirsi con grazia negli spazi domestici e pubblici dedicati al relax. Completa l'offerta il pouf, che riprende l'ovale della poltrona ed è disponibile in due versioni. **Struttura:** Telaio dello schienale in metallo imbottito con poliuretano a densità differenziata, fusto della seduta in legno massello e multistrato imbottito con poliuretano a densità differenziata. Prerivestimento con velfodera accoppiata con fibra poliester. Il rivestimento, ad eccezione della versione in pelle, è completamente sfoderabile. Base di appoggio in MDF verniciato di colore nero. **Contract:** Su richiesta, per forniture, si costruisce con materiali ignifughi.

**Features:** Thanks to the compact dimensions and being inspired by the enveloping shaped of a shell, the armchair Emily represents the ideal combination of comfort and elegance, and gracefully fits both into residential and public areas dedicated to relax. Emily can be combined with a pouf recalling the oval shape of the armchair, and which is available in two versions. The collection is suitable for contract use. **Framework:** The framework of the backrest is in metal padded with different densities polyurethane, the frame of the seat is in solid wood and plywood padded with different densities polyurethane. Lining in Velfodera coupled with polyester fibre. Cover can be completely removed except for the leather version. Feet are in black painted MDF. **Contract:** Available with fire resistant materials upon request.

**Eigenschaften:** Dank seiner kompakten Abmessungen und seiner von einer Muschel inspirierten Form ist der Sessel Emily die ideale Kombination aus Komfort und Eleganz, um sich elegant in Wohn- und öffentliche Bereiche einzufügen, die der Entspannung gewidmet sind. Abgerundet wird das Angebot durch den Hocker, der das Oval des Sessels wieder aufnimmt und in zwei Ausführungen erhältlich ist. Die Kollektion ist für den Objektbereich geeignet. **Struktur:** Rahmen der Rückenlehne aus Metall, gepolstert mit Polyurethan unterschiedlicher Dichte. Korpus des Sitzes aus Massiv- und Mehrschichtholz, gepolstert mit Polyurethan unterschiedlicher Dichte. Schonbezug in Velfodera, gekoppelt mit Polyesterfaser. Bezug, mit Ausnahme von Leder, komplett abziehbar. Basis aus schwarz lackiertem MDF. **Projekt:** Auf Anfrage und für Objektlieferungen kann dieser Sessel mit feuerhemmenden Materialien geliefert werden.

**PIEDE FOOT FUSS**

Base in MDF colorato nero.  
Base in MDF color Black.  
Basis in MDF Farbe Schwarz.

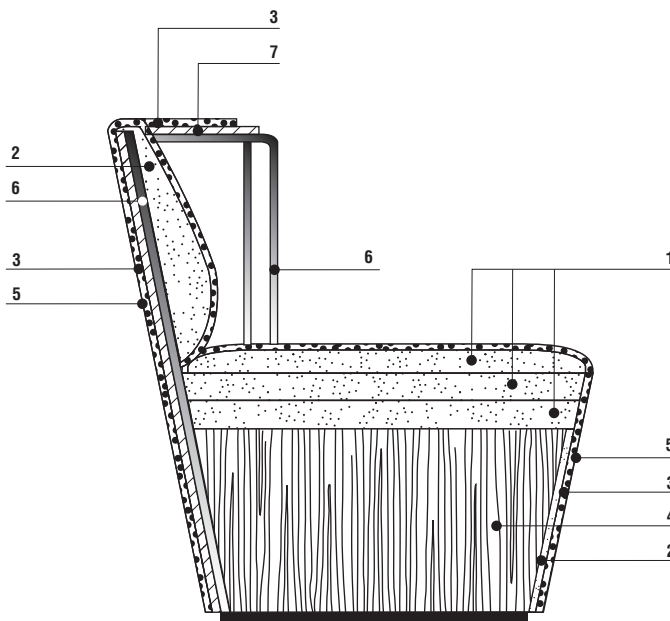
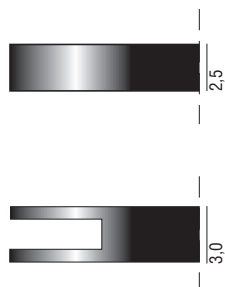

**SEZIONE SECTION SEKTION**

- 1: Poliuretano a densità differenziata.  
Differentiated density polyurethane.  
Polyurethan unterschiedlicher Dichte.
- 2: Poliuretano, Polyurethane, Polyurethan.
- 3: Fibra poliester. Polyester Fibre.  
Polyesterfaser.
- 4: Fusto in legno massello e multistrato.  
Frame in solid wood and plywood.  
Korpus aus Massivholz, und schichtverleimt.
- 5: Velfodera, Velfodera, Velfodera.
- 6: Telaio in metallo, Metal framework.  
Metallrahmen.



**POUF 57x72**



**POUF 57x72 VERSUS**





**Caratteristiche:** Forma rassicurante e concreta, elegante e confortevole, misure "generose". La collezione offre un'ampia gamma di divani, elementi, laterali, angoli che abbinati a piacere offrono innumerevoli combinazioni. Holden è disponibile nella versione "BASE" (senza cuscini-schienali) da completare con i cuscini-schienali scelti fra le diverse misure a disposizione, avendo quindi la possibilità di progettare il divano a piacimento, e nelle versioni "A" e "B": la versione "A" è fornita con schienali di forma classica tradizionale e la versione "B" con cuscini-schienali (cm. 58x58) più accattivanti ed informali in quantità predefinita. Alcuni elementi come i terminali e la dormeuse sono disponibili in due diverse misure di profondità, 103 e 118 cm. Un elemento distintivo importante è dato dalla possibilità di scegliere tra due diverse misure di bracciolo: largo cm. 26 alto cm. 51, oppure il bracciolo BIG largo cm. 39 alto cm. 49. Il rivestimento è completamente sfoderabile. Holden è inoltre attrezzabile con il tavolino Argo. **Struttura:** Fusto in legno massello e multistrato, imbottito in poliuretano espanso indeformabile a densità differenziata, molleggio con nastri elastici intrecciati. Prerivestimento con tela di cotone accoppiata con fibra poliestere. Piedini in faggio laccato colore nero. **Imbottitura:** Cuscini-schienali tipo "A" in piuma lavata e sterilizzata con inserto in poliuretano; cuscini-schienali tipo "B" e "XL" interamente in piuma lavata e sterilizzata. Cuscini seduta in piuma con inserto in poliuretano sempre in versione cuscini divisi. Il cuscino di seduta in piuma offre un comfort speciale oltre a donare un aspetto piacevolmente vissuto, proprio della piuma, che va accettato in quanto inevitabile. Su richiesta si forniscono i cuscini di seduta in poliuretano e fibra poliestere e, in questa versione, sono disponibili sia unici che divisi.

**Features:** A reassuring, solid shape, elegant and comfortable, "generous" proportions. This collection presents a wide array of settees, side elements, corners that can form countless different combinations. Holden is available in the "BASE" version (without backrest cushions), which has to be equipped with backrest cushions to be chosen between several sizes. This allows the end customer to design his own sofa, in accordance with his taste. Holden can also be supplied in the version "A" and in the version "B", with two different types of backrest cushions: the classic shape type "A" and the attractive, informal type "B" (cm.58x58), in pre-determined quantity. Some elements such as end-pieces and the sleeper are available in two different depths, 103 and 118 cm. An important hallmark for this collection is the possibility to choose between two different sizes of armrest, one it's 26 cm thick 51 cm high, or the BIG armrest 39 cm thick 49 cm high. The covers are completely removable. Besides, Holden can be equipped with the small table Argo. **Structure:** Frame in solid wood and plywood, padded with differentiated density non-deformable foamed polyurethane, sprung with interwoven elastic bands. Under-covering in cotton canvas coupled with polyester fibre. Feet in black-stained beech. **Cushion padding:** Type "A" backrest cushions are made of washed and sterilised feather with polyurethane insert; type "B" and XL backrest cushions are made entirely of washed and sterilised feather. Seat cushions in down with polyurethane insert always in separate cushions. The seat cushions in goose down provide special comfort and acquire a pleasant well-worn look, which is a typical feature of down and must be accepted. On request, the seat cushions can be provided in polyurethane and polyester fibre, also available in this version as a joint cushion.

**Eigenschaften:** Beruhigende und konkrete Optik, elegant und bequem, großzügige Maße. Die Kollektion bietet eine breitgefächerte Serie an Sofas, Seiten- und Eckelemente, welche durch das Zusammenfügen nach freier Wahl unzählige Kombinationen bieten. Holden ist erhältlich in der Variante „BASIS“ (ohne Rückenissen), die durch einige Rückenissen ergänzt werden muss und zwischen den verschiedenen verfügbaren Maßen gewählt werden können. Dies erlaubt dem Kunden, seine eigenen Wünsche zu realisieren und sein eigenes Sofa zu kreieren. Dazu existieren zwei Varianten, "A" und "B": Variante "A" ist mit geraden Rückenissen in klassischer, traditioneller Form lieferbar; Variante "B" mit Wurfkissen (58x58 cm), etwas legerer und informeller, in vorgegebener Menge. Einige Elemente, wie die Endteile und die Dormeuse, sind in den zwei Tiefen 103 und 118 cm verfügbar. Ein wichtiges Unterscheidungsmerkmal ist durch die Möglichkeit gegeben, zwischen zwei verschiedenen Größen der Armlehne zu wählen: 26 cm breit, 51 cm hoch oder die Armlehne BIG 39 cm breit und 49 cm hoch. Der Bezug ist komplett abziehbar. Holden kann ebenfalls mit dem Beistelltisch Argo ergänzt werden. **Struktur:** Korpus aus massiver Buche und Mehrschichtholz, Unterfederung durch geflochtene Elastikgurte. Schonbezug aus Baumwolle mit Polyesterfaser. Füße aus schwarz lackierter Buche. **Polster:** Rückenissen Typ "A" aus gewaschenen und sterilisierten Federn mit Polyurethan-Einsatz, Rückenissen Typ "B" nur aus gewaschenen und sterilisierten Federn. Sitzkissen mit Federn und Polyurethaneinsatz, stets als getrennte Kissen. Die Sitzkissen aus Federn bieten einen besonderen Komfort und aufgrund der Federn einen speziellen, legeren Look, welcher als solcher akzeptiert werden muss. Auf Anfrage können die Sitzkissen aus Polyurethan und Polyesterfaser bestehen, und in dieser Ausführung, auch als durchgehende Sitzkissen.

**PIEDE FOOT FUß**

Massello di faggio laccato color nero.  
Solid beech wood stained black.  
Schwarz lackierte massive Buche.

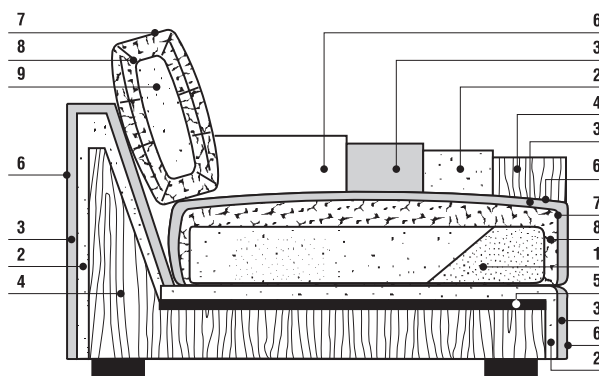

**SEZIONE SECTION SEKTION**

- 1: Poliuretano a densità differenziata.  
Differentiated density polyurethane.  
Polyurethan unterschiedlicher Dichte.
- 2: Poliuretano. Polyurethane. Polyurethan.
- 3: Fibra Poliestere. Polyester Fibre.  
Polyesterfaser.
- 4: Fusto in legno massello e multistrato.  
Frame in solid wood and plywood.  
Korpus aus Massivholz, oder schichtverleimt.
- 5: Nastri elastici. Elastic belts. Elastische Gurte.
- 6: Fodera in tela. Fabric lining. Schonbezug.
- 7: Fodera in tessuto antipiuma.  
Featherproof fabric cover.  
Federnundurchlässiger Bezug des Kisseninlets.
- 8: Piuma. Down. Federfüllung.
- 9: Inserto in Poliuretano. Polyurethane insert.  
Einsatz aus Polyurethan.

**HOLDEN VERSIONE BASE**

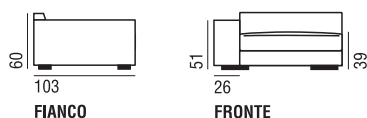

**HOLDEN VERSIONE A**

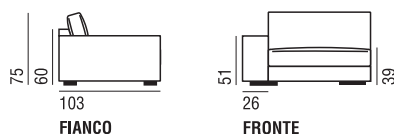

**HOLDEN VERSIONE B**

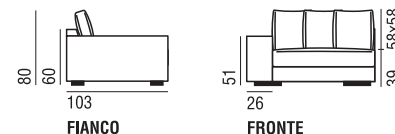

**HOLDEN BIG VERSIONE BASE**

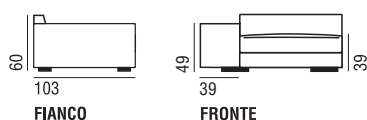

**HOLDEN BIG VERSIONE A**

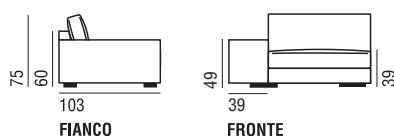

**HOLDEN BIG VERSIONE B**

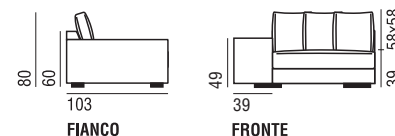

**HOLDEN MODULI CON BRACCIOLI 26 CM. VERSIONE A**

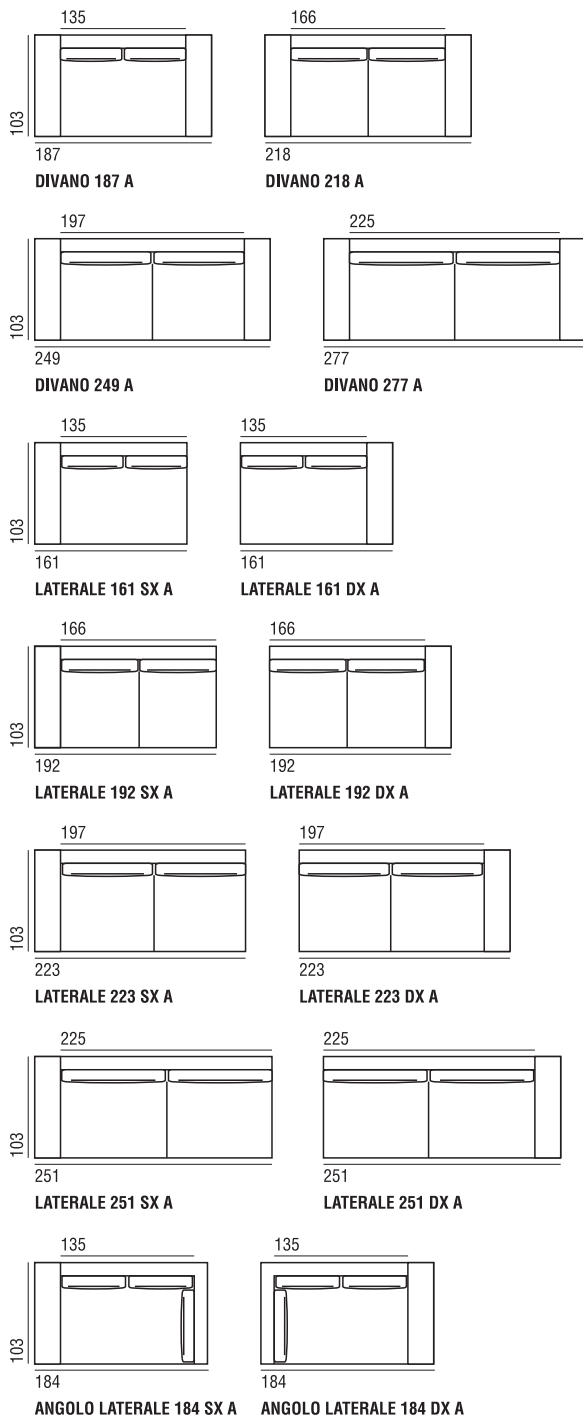

**HOLDEN MODULI CON BRACCIOLI 26 CM. VERSIONE B**

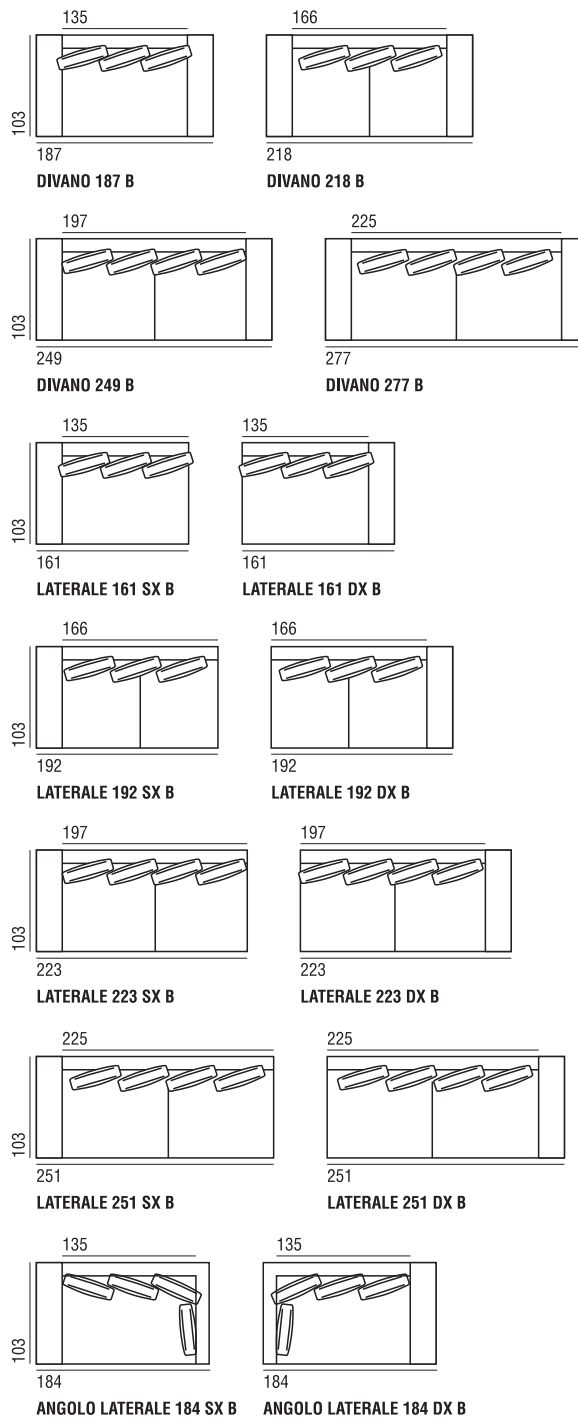

**HOLDEN MODULI CON BRACCIOLI 26 CM. VERSIONE A**

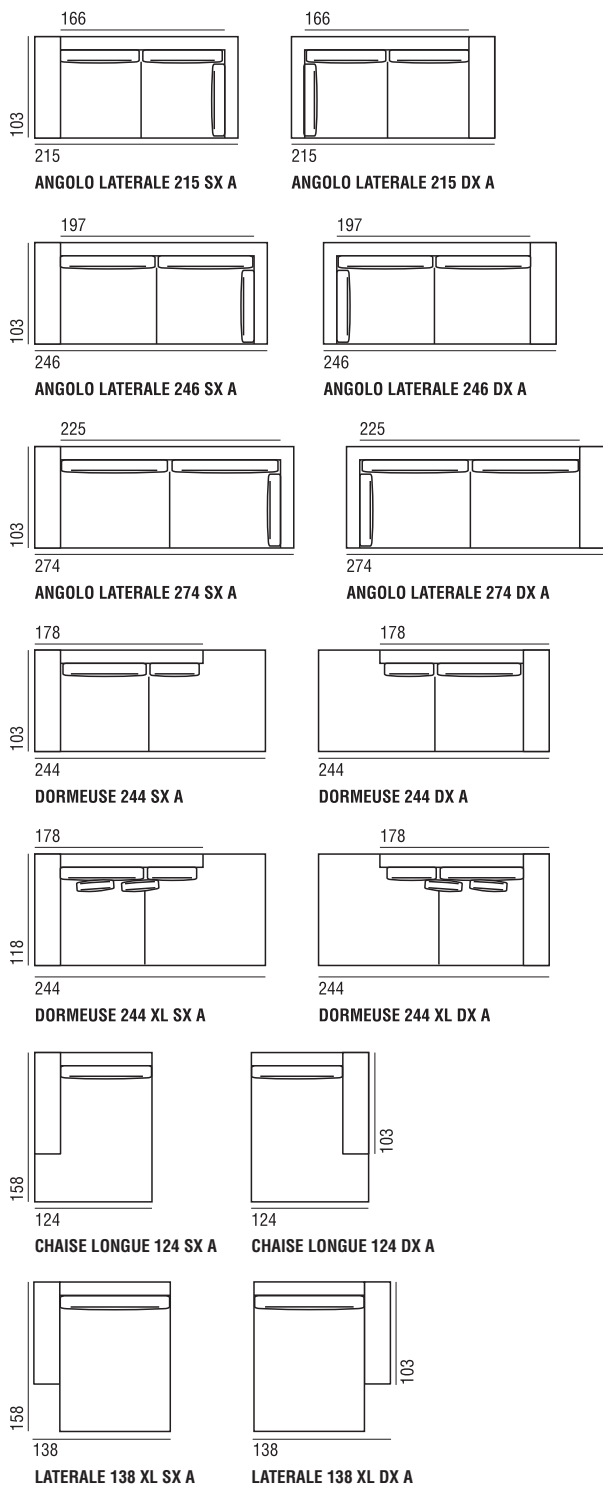

**HOLDEN MODULI CON BRACCIOLI 26 CM. VERSIONE B**

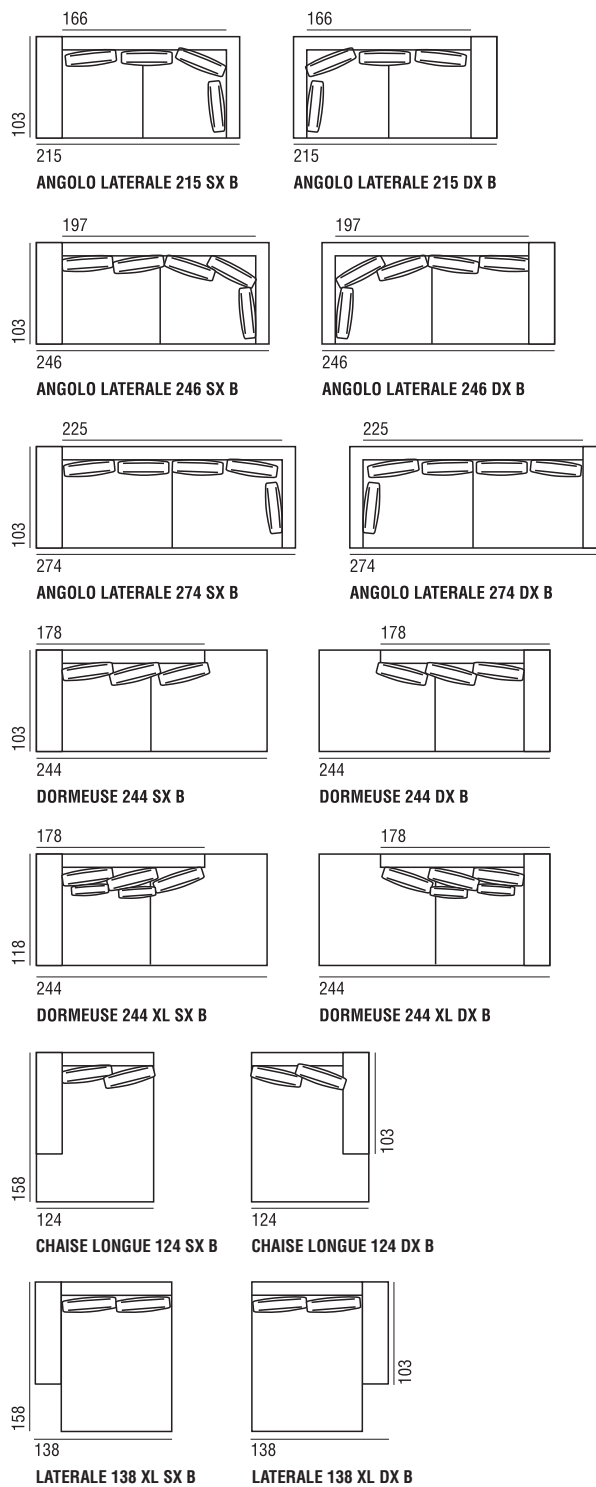

**HOLDEN MODULI CON BRACCIOLI BIG 39 CM. VERSIONE A**

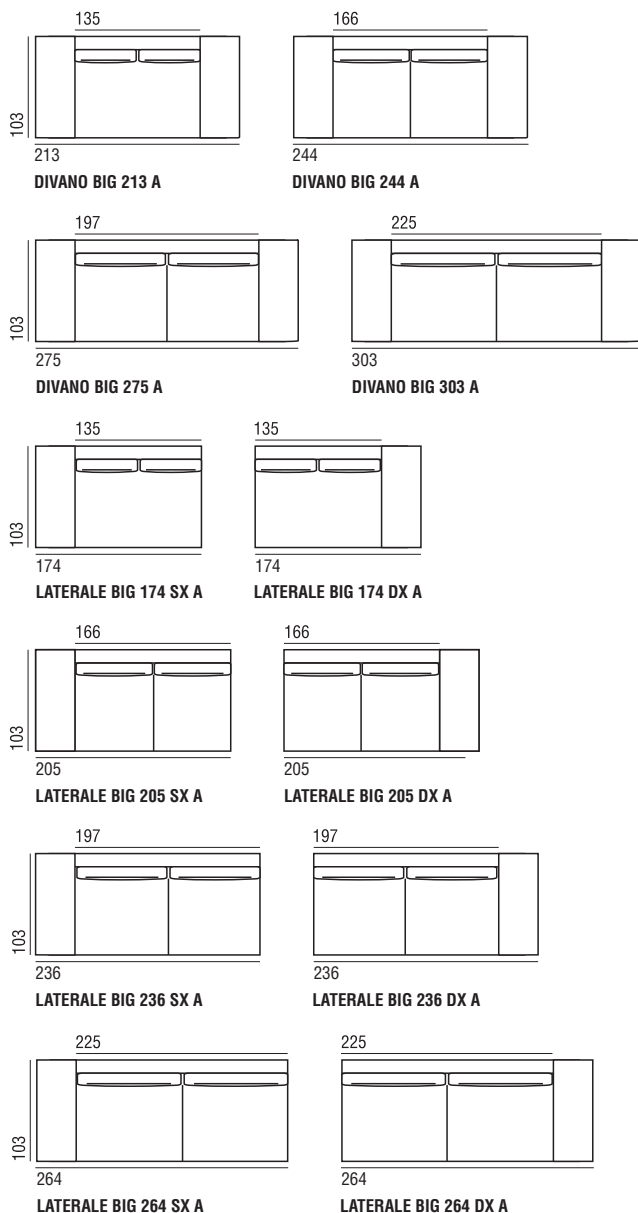

**HOLDEN MODULI CON BRACCIOLI BIG 39 CM. VERSIONE B**

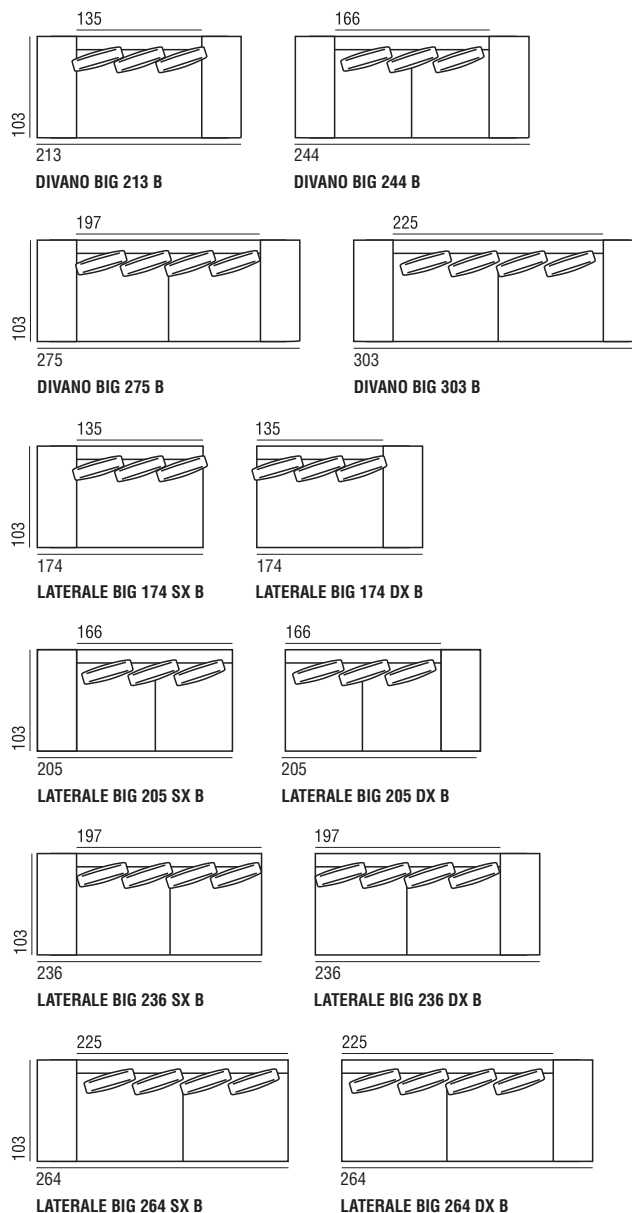



**HOLDEN MODULI CON BRACCIOLI BIG 39 CM. VERSIONE A**

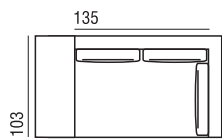

135  
197  
**ANGOLO LATERALE BIG 197 SX A**

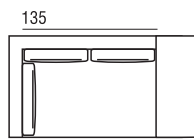

135  
197  
**ANGOLO LATERALE BIG 197 DX A**

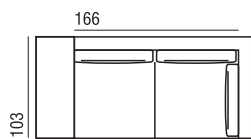

166  
228  
**ANGOLO LATERALE BIG 228 SX A**

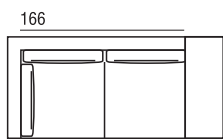

166  
228  
**ANGOLO LATERALE BIG 228 DX A**

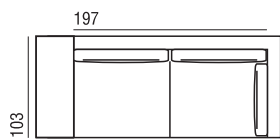

197  
259  
**ANGOLO LATERALE BIG 259 SX A**

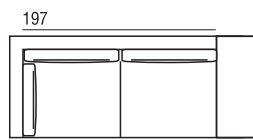

197  
259  
**ANGOLO LATERALE BIG 259 DX A**

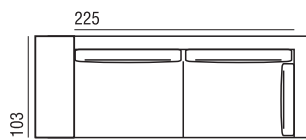

225  
287  
**ANGOLO LATERALE BIG 287 SX A**

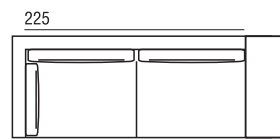

225  
287  
**ANGOLO LATERALE BIG 287 DX A**

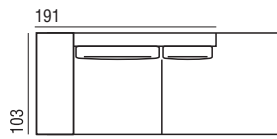

191  
257  
**DORMEUSE BIG 257 SX A**

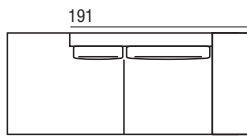

191  
257  
**DORMEUSE BIG 257 DX A**

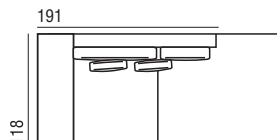

191  
257  
**DORMEUSE BIG 257 XL SX A**

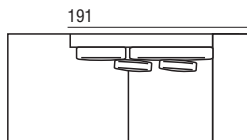

191  
257  
**DORMEUSE BIG 257 XL DX A**

**HOLDEN MODULI CON BRACCIOLI BIG 39 CM. VERSIONE B**

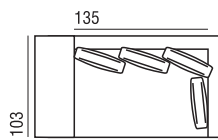

135  
197  
**ANGOLO LATERALE BIG 197 SX B**

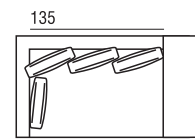

135  
197  
**ANGOLO LATERALE BIG 197 DX B**

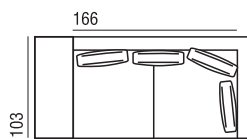

166  
228  
**ANGOLO LATERALE BIG 228 SX B**

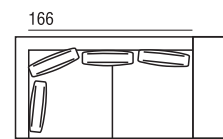

166  
228  
**ANGOLO LATERALE BIG 228 DX B**

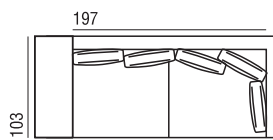

197  
259  
**ANGOLO LATERALE BIG 259 SX B**

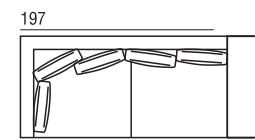

197  
259  
**ANGOLO LATERALE BIG 259 DX B**

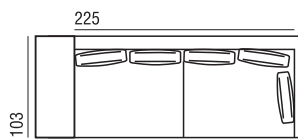

225  
287  
**ANGOLO LATERALE BIG 287 SX B**

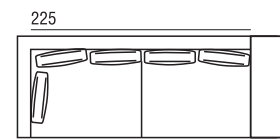

225  
287  
**ANGOLO LATERALE BIG 287 DX B**

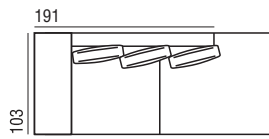

191  
257  
**DORMEUSE BIG 257 SX B**

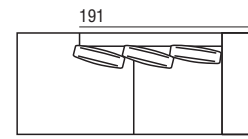

191  
257  
**DORMEUSE BIG 257 DX B**

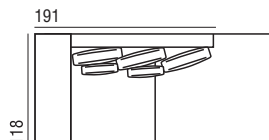

191  
257  
**DORMEUSE BIG 257 XL SX B**

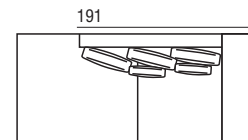

191  
257  
**DORMEUSE BIG 257 XL DX B**

**HOLDEN MODULI CON BRACCIOLI BIG 39 CM. VERSIONE A**

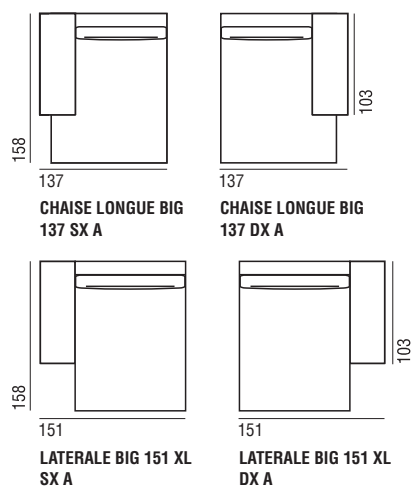

**HOLDEN MODULI CON BRACCIOLI BIG 39 CM. VERSIONE B**

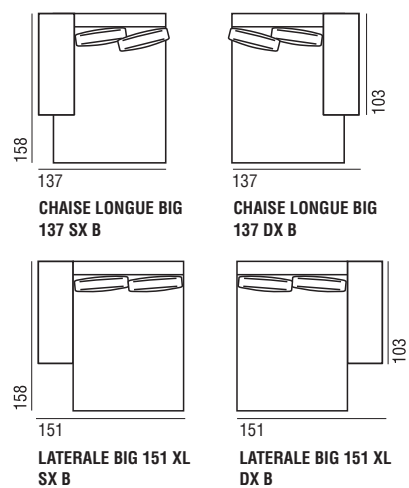

**HOLDEN MODULI SENZA BRACCIOLI VERSIONE A**

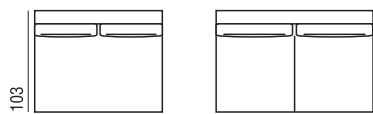

135  
**ELEMENTO 135 A**

166  
**ELEMENTO 166 A**

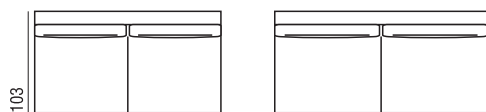

197  
**ELEMENTO 197 A**

225  
**ELEMENTO 225 A**

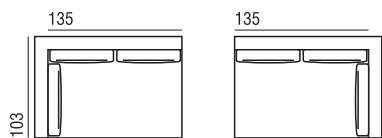

135  
158  
**ANGOLO 158 SX A**

135  
158  
**ANGOLO 158 DX A**

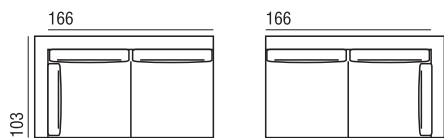

166  
189  
**ANGOLO 189 SX A**

166  
189  
**ANGOLO 189 DX A**

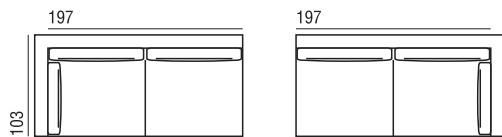

197  
220  
**ANGOLO 220 SX A**

197  
220  
**ANGOLO 220 DX A**

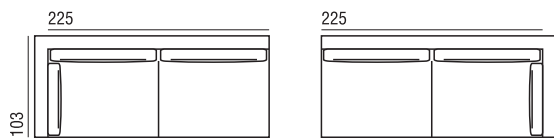

225  
248  
**ANGOLO 248 SX A**

225  
248  
**ANGOLO 248 DX A**

**HOLDEN MODULI SENZA BRACCIOLI VERSIONE B**

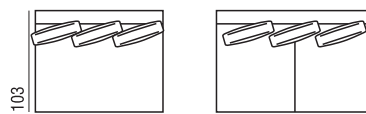

135  
**ELEMENTO 135 B**

166  
**ELEMENTO 166 B**

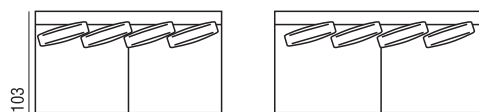

197  
**ELEMENTO 197 B**

225  
**ELEMENTO 225 B**

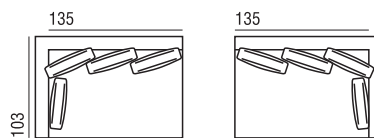

135  
158  
**ANGOLO 158 SX B**

135  
158  
**ANGOLO 158 DX B**

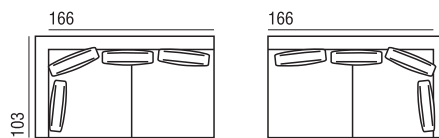

166  
189  
**ANGOLO 189 SX B**

166  
189  
**ANGOLO 189 DX B**

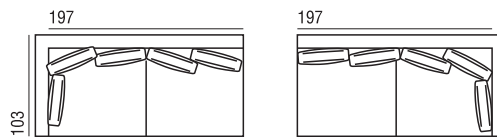

197  
220  
**ANGOLO 220 SX B**

197  
220  
**ANGOLO 220 DX B**

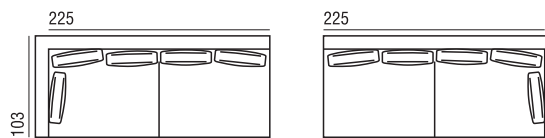

225  
248  
**ANGOLO 248 SX B**

225  
248  
**ANGOLO 248 DX B**

**HOLDEN MODULI SENZA BRACCIOLI VERSIONE A**

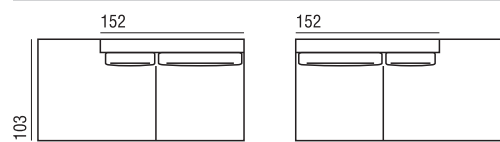

**TERMINALE 218 SX A**

**TERMINALE 218 DX A**

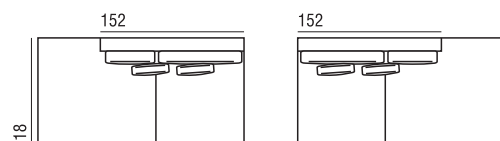

**TERMINALE 218 XL SX A**

**TERMINALE 218 XL DX A**

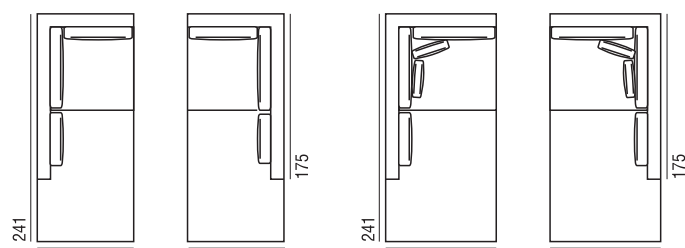

**DORMEUSE ANGOLO 103 SX A**

**DORMEUSE ANGOLO 103 DX A**

**DORMEUSE ANGOLO 118 SX A**

**DORMEUSE ANGOLO 118 DX A**

**HOLDEN MODULI SENZA BRACCIOLI VERSIONE B**

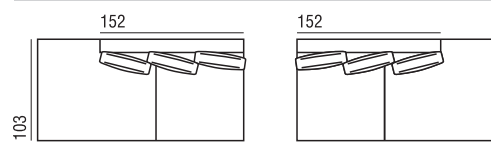

**TERMINALE 218 SX B**

**TERMINALE 218 DX B**

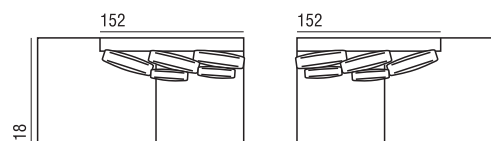

**TERMINALE 218 XL SX B**

**TERMINALE 218 XL DX B**

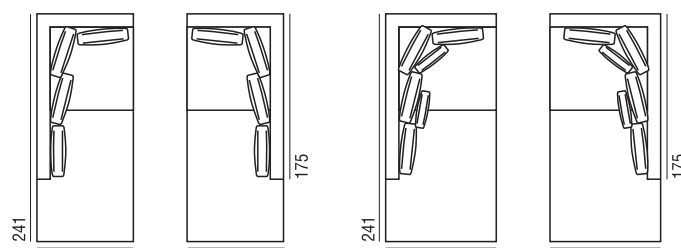

**DORMEUSE ANGOLO 103 SX B**

**DORMEUSE ANGOLO 103 DX B**

**DORMEUSE ANGOLO 118 SX B**

**DORMEUSE ANGOLO 118 DX B**

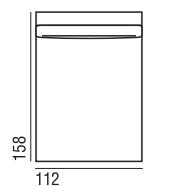

**ELEMENTO 112 XL A**

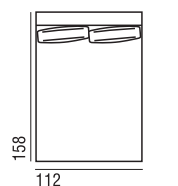

**ELEMENTO 112 XL B**

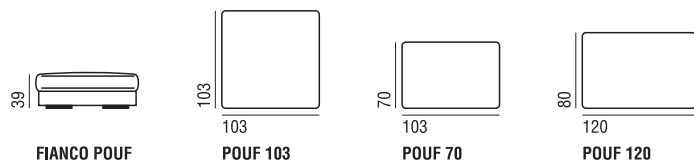

**FIANCO POUF**

**POUF 103**

**POUF 70**

**POUF 120**

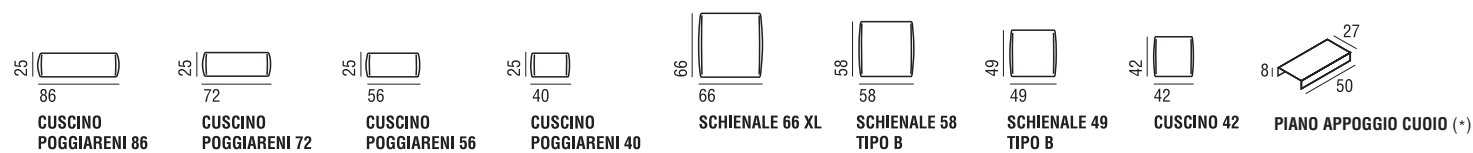

**CUSCINO POGGIARENI 86**

**CUSCINO POGGIARENI 72**

**CUSCINO POGGIARENI 56**

**CUSCINO POGGIARENI 40**

**SCHIENALE 66 XL**

**SCHIENALE 58 TIPO B**

**SCHIENALE 49 TIPO B**

**CUSCINO 42**

**PIANO APPOGGIO CUIOIO (\*)**

(\*) disponibile solo con bracciolo 26 cm / available with armrest 26 cm only / nur mit Armlehne 26 cm erhältlich



**Caratteristiche:** Zoe si distingue per il design informale e per il particolare comfort. La collezione è composta da Poltrona XL, Large, Small, Baby, Chaise Longue e da pouf di diverse dimensioni, disponibili anche in versione Outdoor. A seconda del rivestimento scelto la fodera si realizza in tre diverse finiture: Al Vivo, Con Bordino o con impuntura "Punto Cavallo". La finitura "Punto Cavallo" si fornisce con supplemento di prezzo. Sconsigliamo i tessuti troppo leggeri. La collezione Zoe è completamente sfoderabile. Le misure riportate, essendo costruita con materiale "mobile", sono indicative. **Finiture disponibili:** - "Al Vivo": Si esegue esclusivamente con i tessuti idonei (vedi listino prezzi) così come con tutti i tipi di pelle. In pelle, di serie, si realizza solo Al Vivo. - "Con Bordino": Con tutti gli altri tessuti la cucitura è di tipo tradizionale e con bordino dello stesso tessuto e colore. - "Punto Cavallo": Si tratta di un'impuntura decorativa disponibile in 11 colori (vedi listino prezzi) da abbinare a piacere al tessuto scelto. Il tessuto è da selezionare fra quelli idonei. Questa finitura si fornisce con supplemento di prezzo. **Zoe Outdoor:** Nella versione Outdoor vengono impiegati tessuti idrofughi, resistenti ai raggi solari e agli agenti atmosferici, la fodera interna è anch'essa idrofuga ed entrambe sono cucite con filati speciali imputrescibili. Adatta a un uso sottoportico può sopportare una pioggia non intensa. In questo caso è necessario rimuovere l'eventuale acqua stagnante e lasciare asciugare la poltrona completamente e, se occorre, aprire la fodera e lasciare l'interno al sole per una completa asciugatura. **Struttura:** Realizzata senza nessun telaio di sostegno, è modellata da una fodera in cotone 100% Twill, confezionata con camere separate, contenenti perline di polistirene espanso. Il numero delle camere delle poltrone varia a seconda della loro dimensione: 6 nella Chaise Longue, 5 nella poltrona XL, Large, Small e 3 nella Baby. Ogni camera è appositamente costruita con una cerniera provvista di tasca di sicurezza. Date le caratteristiche intrinseche del polistirene espanso, che non assicura costanza di densità, non è possibile garantire l'omogeneità di riempimento tra una poltrona e l'altra e si deve pertanto considerare accettabile una tolleranza di  $\pm 5\%$  del volume di riempimento. Le perline di polistirene espanso, con l'uso, possono perdere leggermente di volume; questo è normale. Il volume iniziale si può ripristinare aggiungendo nuove perline di polistirene espanso in una o più camere.

**Features:** Zoe distinguishes itself for its comfort and its casual design. The collection includes Armchairs XL, Large, Small and Baby, Chaise Longue, and pouf in different sizes, all available in Outdoor version too. According to upholstery cover is provided in three finishes: Visible Seams, Classical Stitching or with "Punto Cavallo" stitching. "Punto Cavallo" finish is available with up charge. We do not recommend fabrics that are too lightweight. The cover is fully removable. As Zoe is made with "mobile" material, the sizes indicated are approximate. **Available Finishes:** - "Visible Seams": Can be provided with suitable fabric (see price list) as well as with any kind of leather. In leather Zoe is provided as standard with Visible Seams only. - "Classical Stitching": With all other fabrics we provide classical stitching with piping in the same fabric and colour. - "Punto Cavallo": Decorative stitching available in 11 colours (see price list) to be matched at pleasure with the fabric. Fabric has to be chosen among those specified as suitable. This finish is available with up charge. **Zoe Outdoor:** In outdoor version Zoe is delivered with water repellent as well as sun's ray and general atmospheric agents resistant fabric, under cover is provided with water repellent materials too, and both covers are sewed with mould resistant yarn. Zoe Outdoor is suitable for screened-in porches use, it can stand a gentle rain, but in this event we advise to remove stagnant water and let the item completely dry. If necessary, remove the cover and let the padding completely dry in the sun. **Framework:** It is built with no supporting frame, is shaped by a 100% Twill cotton cover, and made with separate chambers, containing expanded polystyrene pearls. The number of chambers changes according to the size of the armchair: 6 in the Chaise Longue, 5 in the XL, Large and in the Small and 3 in the Baby armchair. Each chamber is made with a zip equipped with a safety pocket. In account of the specific characteristics of the expanded polystyrene, which does not assure a constant density, it is not possible to guarantee that each Zoe chair will have the same volume. Please allow a + or - 5% tolerance of the filling volume. With the daily use, the expanded polystyrene pearls might lose volume. This is also normal. Original volume can be obtained by adding new expanded polystyrene pearls to one or more chambers.

**Eigenschaften:** Zoe zeichnet sich durch sein informelles Design und seinen besonderen Komfort aus. Die Kollektion umfasst die Sessel XL, Large, Small, Baby, die Chaiselongue und Hocker verschiedener Größen; alle auch in der Version Outdoor lieferbar. Je nach Wahl des Bezugs werden drei verschiedene Nähte genäht: Klaffnaht, Kedernaht oder die Ziernaht „Punto Cavallo“. Die Verarbeitung mit der Ziernaht „Punto Cavallo“ erfolgt gegen Aufpreis. Für Zoe wird von leichten Stoffen abgeraten. Die Kollektion Zoe ist komplett abziehbar. Die angegebenen Maße sind Richtwerte, da das Material modellierbar ist. **Ausführbare Nähte:** - „Klaffnaht“: wird ausnahmslos nur bei dazu geeigneten Stoffen (siehe Preisliste) und allen Lederarten verarbeitet. Die Standardausführung bei Lederbezügen ist immer mit Klaffnaht. - „Kedernaht“: Alle anderen Stoffe haben die traditionelle Naht mit Keder des gleichen Stoffes und der gleichen Farbe. - „Punto Cavallo“: Es handelt sich um einen Zierstich, der in 11 verschiedenen Farben (siehe Preisliste) realisierbar und mit dem gewählten, dafür geeigneten, Stoff kombinierbar ist. Diese Ziernaht ist gegen Aufpreis erhältlich. **Zoe Outdoor:** Für die Outdoor Version werden wasserabweisende Stoffe verwendet, die gegen Sonnenlicht und Witterungseinflüsse resistent sind. Auch der Unterbezug ist wasserabweisend und beide sind mit speziellem und verwesungsbeständigem Garn genäht. Zoe Outdoor eignet sich für die Nutzung im überdachten Außenbereich und hält leichte Regenfälle aus. Eventuell in den Sitzen stehendes Wasser sollte jedoch nach dem Regen entfernt und die Sessel sollten vollständig getrocknet werden. Wenn nötig, sollte der Bezug geöffnet und der Sack in die Sonne gelegt werden, um den Sessel vollständig trocknen zu lassen. **Struktur:** Zoe ist ohne jeglichen Stützrahmen, geformt aus einem 100% BaumwollTwillBezug, mit getrennten Kammern, die mit Polystyrolkugeln gefüllt sind. Die Anzahl der Kammern hängt von der Größe des Sessels ab: 6 bei der Chaiselongue, 5 bei den Sesseln XL, Large und Small und 3 beim Baby. Jede Kammer ist mit Reißverschluss mit Sicherheitstasche versehen. Aufgrund der dem Polystyrolkugeln eigenen Charakteristika, die eine konstante Dichtigkeit nicht gewährleisten, ist es nicht möglich, die Homogenität der Füllung von Sessel zu Sessel zu garantieren. Eine Toleranz von  $\pm 5\%$  des Volumens der Füllung ist also zu akzeptieren. Durch die tägliche Benutzung können die Polystyrolkugeln an Volumen verlieren, was normal ist. Das ursprüngliche Volumen kann, durch Wiederauffüllen mit Polystyrolkugeln in eine oder mehrere der Kammern wiederhergestellt werden.

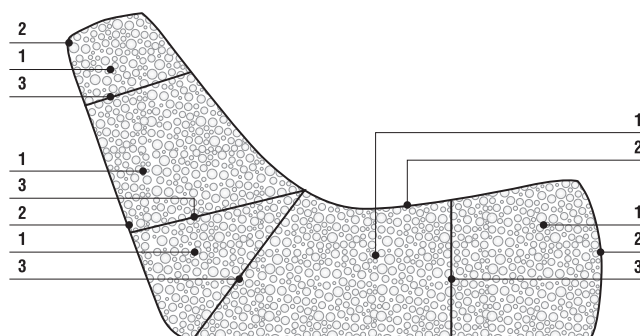

**SEZIONE SECTION SEKTION**

- 1: Perline di polistirene espanso.  
Expanded polystyrene pearls.  
Polystyrolkugeln
- 2: Cotone 100% twill.  
100% Twill cotton.  
100% Baumwolltwill.
- 3: Tramezze in cotone 100% twill.  
100% Twill cotton tape.  
Zwischenbänder aus 100% Baumwolltwill.

**ZOE XL**

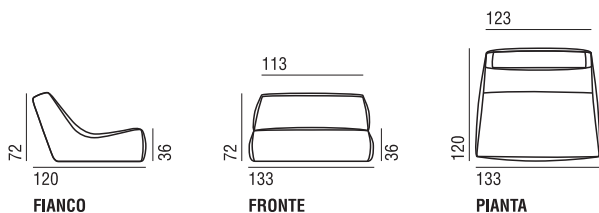

**ZOE LARGE**

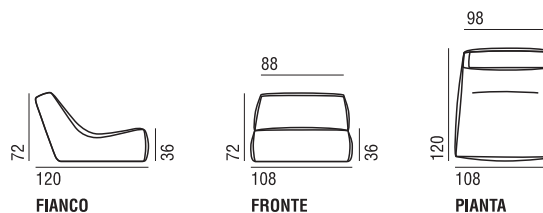

**ZOE SMALL**

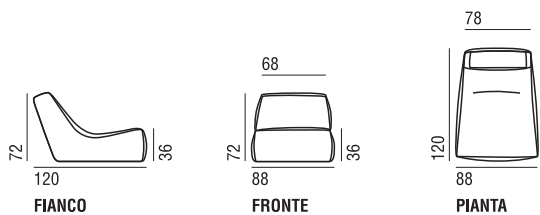

**ZOE BABY**

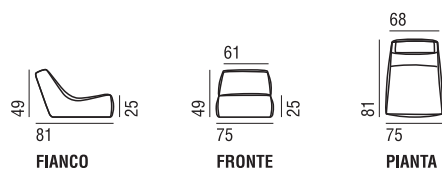

**ZOE CHAISE LONGUE**

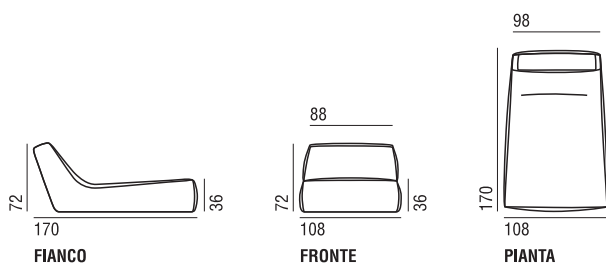

**ZOE POUF**

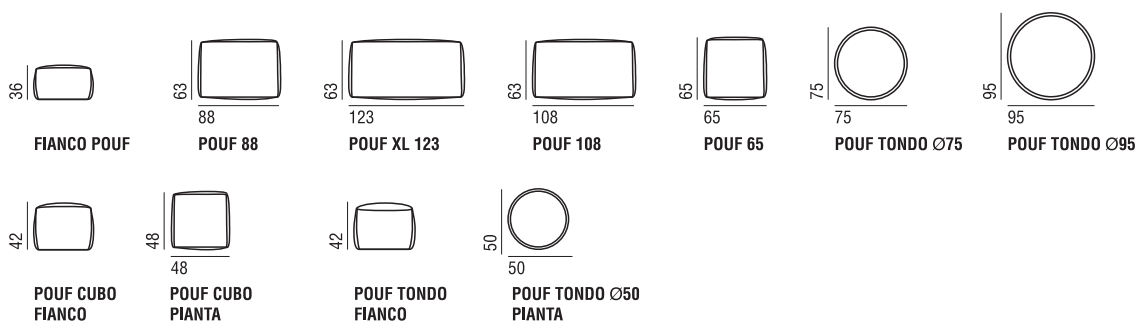



**Caratteristiche:** ZOE MORE nasce dalla storia e dall'esperienza della poltrona ZOE, presentata per la prima volta nel 2006 e diventata in pochi anni un'icona del design. La caratteristica di Zoe è la struttura realizzata con perline di polistirene espanso, la caratteristica di ZOE MORE è la struttura realizzata in poliuretano autoportante e fibra poliestere tipo Ball mista a Rhombo-fill®. La diversa struttura assicura l'eleganza ed il senso delle proporzioni che ha sancito il successo di ZOE in tutti questi anni ed offre un comfort di seduta diverso e complementare rispetto alla ZOE primigenia. La collezione è composta da Poltrona XL, Large, Small, Chaise Longue e da vari pouf. A seconda del rivestimento scelto, la fodera si realizza in tre diverse finiture: Al Vivo, con bordino o con impuntura "Punto Cavallo". Sconsigliamo i tessuti troppo leggeri. La collezione ZOE MORE è completamente sfoderabile è attrezzabile con il tavolino Argo. Le misure riportate, essendo costruita con materiale "mobile", sono indicative. **Finiture disponibili:** - **"Al Vivo":** Si esegue esclusivamente con i tessuti idonei (vedi listino prezzi) così come con tutti i tipi di pelle. In pelle, di serie, si realizza solo Al Vivo. - **"Con Bordino":** Con tutti gli altri tessuti la cucitura è di tipo tradizionale e con bordino dello stesso tessuto e colore. - **"Punto Cavallo":** Si tratta di un'impuntura decorativa, disponibile in 11 colori, da abbinare a piacere al tessuto scelto. Il tessuto è da selezionare fra quelli idonei (vedi listino prezzi). Questa finitura si fornisce con supplemento di prezzo. **Struttura/Imbottitura:** Realizzata senza nessun telaio di sostegno. Imbottitura in parte in poliuretano rigido e autoportante, che fa da struttura, e in parte in poliuretani di diverse densità, idonei ad assicurare un elevato comfort. Le parti interne dello schienale e della seduta sono imbottite con una miscela di fibra poliestere tipo Ball e Rhombo-fill®, contenuta in una fodera confezionata con diversi scomparti, ottenuti con numerose tramezze. Tutte le parti esterne invece sono rivestite da fibra poliestere in falda, rivestita a sua volta da tela di cotone. L'imbottitura in fibra poliestere tipo Ball e Rhombo-fill®, offre un comfort speciale, oltre a donare un aspetto particolarmente vissuto, proprio di questa imbottitura che va accettato in quanto voluto.

**Features:** ZOE MORE comes from the history and experience of the ZOE armchair, presented for the first time in 2006 and become a design icon in just a few years. The characteristic of Zoe is the structure made with expanded polystyrene pearls, the characteristic of ZOE MORE is the structure made of self-supporting polyurethane and polyester fiber Ball type mixed with Rhombo-fill®. The different structure ensures the elegance and sense of proportion that has made the success of ZOE in all these years and offers a different seating comfort and complementary to the ZOE original. The collection consists of XL, Large, Small armchairs, Chaise Longue and various poufs. According to upholstery cover is provided in three finishes: Visible Seams, Classical Stitching or with "Punto Cavallo" stitching. We do not recommend fabrics that are too thin. The ZOE MORE collection has completely removable cover and can be equipped with Argo table. The measures shown, being built with "mobile" material, are indicative. **Available Finishes:** - **"Visible Seams":** Can be provided with suitable fabric (see price list) as well as with any kind of leather. In leather Zoe is provided as standard with Visible Seams only. - **"Classical Stitching":** With all other fabrics we provide classical stitching with piping in the same fabric and colour. - **"Punto Cavallo":** Decorative stitching available in 11 colours to be matched at pleasure with the fabric. Fabric has to be chosen among those specified as suitable (see price list). This finish is available with up charge. **Framework / Padding:** Made without any support frame. Padding in rigid and self-supporting polyurethane, which acts as a structure, and in polyurethanes of different densities, suitable for ensuring high comfort. The internal parts of the back and seat are padded with a mixture of polyester fiber Ball type and Rhombo-fill®, contained in a lining made up of several compartments, obtained with numerous partitions. All the external parts, on the other hand, are covered with polyester fiber in a layer, covered in turn by a cotton cloth. The padding in polyester fiber Ball type and Rhombo-fill®, offers a special comfort, as well as giving a specific look, just typical of this padding that must be accepted as it is as specific product feature.

**Eigenschaften:** ZOE MORE entsteht aus der Geschichte und Erfahrung des ZOE-Sessels, der 2006 erstmals präsentiert und in wenigen Jahren zu einer Design-Ikone wurde. Die Charakteristik des Zoe ist die Struktur aus Polystyrol-Kügelchen, während die des ZOE MORE eine selbsttragende Struktur aus Polyurethan und Polyesterfaser Typ Ball gemischt mit Rhombo-Fill® ist. Die andersartige Struktur garantiert die Eleganz und das Gefühl für Proportionen, die den Erfolg von ZOE in all diesen Jahren ausgemacht haben und bietet einen anderen, komplementären Sitzkomfort zur ursprünglichen ZOE. Die Kollektion besteht aus Sessel XL, Large, Small, Chaiselongue und verschiedenen Hockern. Je nach Wahl des Stoffes, wird der Bezug in drei verschiedenen Verarbeitungen realisiert: Klaffnaht, Kedernaht oder mit dem Zierstich "Punto Cavallo". Wir raten jedoch von zu leichten Stoffen ab. Die Beistelltische Argo sind eine geeignete Ergänzung. Die angegebenen Maße sind indikativ, da es sich um „mobiles“ Material handelt. **Verfügbare Verarbeitungen:** - **„Klaffnaht“:** Sie wird ausschließlich mit den dafür geeigneten Stoffen (siehe Preisliste) sowie mit allen Lederarten durchgeführt. Leder wird standardmäßig nur mit Klaffnaht verarbeitet. - **„Kedernaht“:** Bei allen anderen Stoffen ist die traditionelle Naht mit Keder aus demselben Stoff und derselben Farbe. - **„Punto Cavallo“:** Diese Ziernaht, die in 11 Farben erhältlich ist, kann mit den dafür geeigneten Stoffen, je nach Wunsch, kombiniert werden (siehe Preisliste). Die Verarbeitung wird gegen Aufpreis geboten. **Struktur / Polsterung:** Hergestellt ohne jeglichen Stützrahmen. Polsterung zum Teil aus steifem und selbsttragendem Polyurethan, das als Struktur dient, und zum Teil aus Polyurethanen differenzierter Dichten, um hohen Komfort zu sichern. Die Innenseiten der Rückenlehne und der Sitzfläche sind mit einer Polyesterfasermischung Typ Ball und Rhombo-fill® gepolstert, die in ein Futter mit mehreren genähten Kammern, gefüllt sind. Alle Außenseiten sind dagegen mit einer Schicht Polyesterfaser verkleidet, die ihrerseits mit einem Baumwollstoff bezogen ist. Die Polsterung in Polyesterfaser Typ Ball gemischt mit Rhombo-fill®, bietet einen besonderen Komfort, sowie ein dieser Polsterung eigenes, besonders „gelebtes“ Aussehen, das akzeptiert werden muss, da so gewollt.

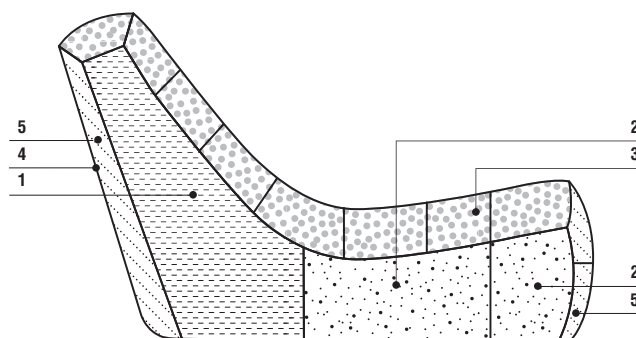

#### SEZIONE SECTION SEKTION

- 1: Poliuretano rigido autoportante.  
Self-supporting rigid polyurethane.  
Selbsttragendes steifes Polyurethan.
- 2: Poliuretano a densità differenziata.  
Differentiated density polyurethane.  
Polyurethan differenzierter Dichten.
- 3: Miscela di Fibra Poliestere tipo Ball e Rhombo-fill® (insacchettata).  
Mixture of Polyester Fiber type Ball and Rhombo-fill® (bagged).  
Mischung aus Polyesterfaser Typ Ball und Rhombo-fill® (in Kammern gefüllt).
- 4: Fodera in tela. Fabric lining. Schonbezug.
- 5: Fibra Poliestere. Polyester Fibre.  
Polyesterfaser.

**ZOE MORE XL**

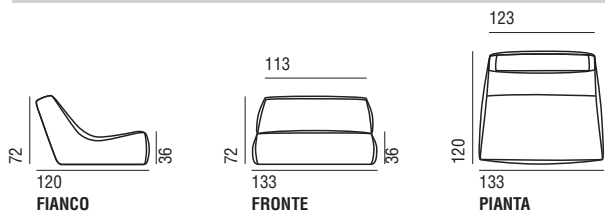

**ZOE MORE LARGE**

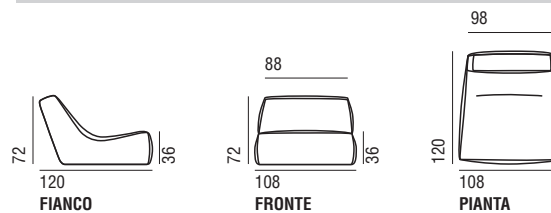

**ZOE MORE SMALL**

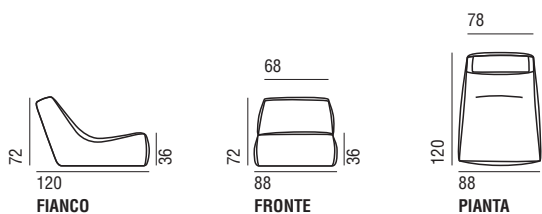

**ZOE MORE CHAISE LONGUE**

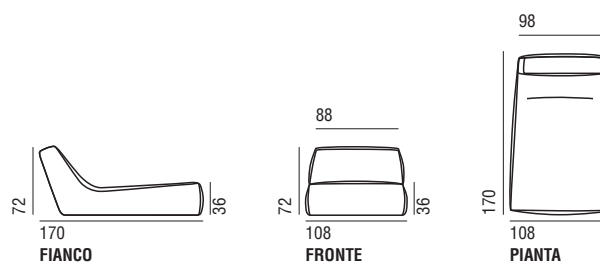

**ZOE MORE POUF**

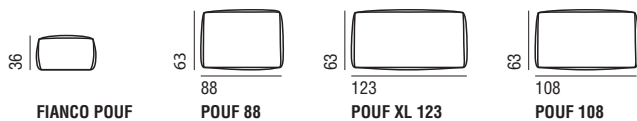





**Caratteristiche:** Nilson è un modello dalla linea innovativa la cui caratteristica principale è l'elevata comodità. È disponibile in due versioni: con lo schienale Alto o con lo schienale Basso. La versione Alta (alla quale raccomandiamo di aggiungere i cuscini bracciolo opzionali) è dotata di un poggiatesta reclinabile in diverse posizioni che lo rende ergonomicamente perfetto, offrendo una comodità insuperabile. Nilson, nella versione Basso (che può "vivere" anche senza cuscini bracciolo), è dedicato a chi preferisce una seduta informale dal tratto contemporaneo. Per entrambe le versioni sono disponibili tre diverse misure di divani, tre diverse misure di laterali oltre alla chaise longue, alla poltrona lunga, al daybed e un pouf. La poltrona girevole con il suo pouf completa la collezione. Il rivestimento è completamente sfoderabile ad eccezione della versione in pelle. **Optional:** Il bracciolo su richiesta e con supplemento è disponibile in cuoio tagliato e cucito al vivo color testa di moro oppure rivestito con le pelli disponibili in campionario. **Struttura:** Fusto in legno multistrato e massello imbottito in poliuretano espanso indeformabile, prerivestimento con Velfodera, piedi in fusione di alluminio verniciati color bronzo. **Imbottiture:** Cuscini di seduta in poliuretano indeformabile a densità differenziata e fibra poliestere, cuscini schienale in piuma canalizzata con inserto in poliuretano indeformabile. I cuscini bracciolo (opzionali) sono interamente in piuma. Tutte le imbottiture sono interamente rivestite in tela bianca.

**Features:** Nilson is a model with an innovative design characterized by a high level of comfort. It is available in two versions: with High or Low backrest. The High version - for which the optional armrest cushions are recommended - is provided with a reclinable headrest, which makes it ergonomically perfect and offers an amazing comfort. Nilson in the Low version - that can "live" without armrest cushions - is thought for those who prefer an informal seat and a contemporary style. Three sizes of sofas, three sizes of side pieces, a chaise longue, a long armchair, a daybed and a pouf are available for both versions. A swivel armchair and a pouf complete the range. The cover can be completely and easily removed except for the leather version. **Optional:** The armrest upon request is available in dark brown cowhide leather with visible cut and sew or upholstered with the leathers available in collection. **Framework:** Frame made of solid and plywood, padded with non-deformable expanded polyurethane of differentiated density. Lining in Velfodera. Feet are in bronzed painted aluminium cast as standard. **Cushion Padding:** Seat cushions in non-deformable expanded polyurethane with differentiated density and polyester fibre, backrest-cushions in canalised feathers with non-deformable polyurethane insert. Optional armrest cushions are entirely in feather. All padding is fully lined with white fabric.

**Eigenschaften:** Nilson ist ein Modell innovativer Linie, dessen Hauptmerkmal der hohe Grad an Komfort ist. Es ist erhältlich in zwei Versionen: mit hoher oder niedriger Rückenlehne. Die „Hohe Version“ (empfehlenswert sind hier die optionalen Armlehnkissen) mit der neigbaren Kopfstütze bietet eine perfekte Ergonomie und extremen Komfort. Die niedrige Version (sie kann auch ohne Armlehnkissen „leben“) richtet sich an diejenigen, die das Informelle und moderne Linien lieben. Für beide Versionen sind drei verschiedene Größen der Sofas, drei verschiedene Größen der Seitenteile, die Chaiselongue, der Longchair und das Daybed verfügbar. Der Drehsessel mit seinem Hocker vervollständigt die Kollektion. Die Bezüge sind komplett abnehmbar, mit Ausnahme der Lederausführung. **Optional:** Die Armlehne ist auf Anfrage und gegen Aufpreis (siehe Preislistenzeile) auch mit den Ledern der Musterkollektion erhältlich oder in dunkelbraunem Rindsleder mit sichtbarem Schnitt und Steppnaht. **Struktur:** Korpus aus Massiv- und Mehrschichtholz, gepolstert mit formstabilem Polyurethan und Unterbezug Velfodera. Füße in bronzefarben lackiertem Aluminiumguss. **Polster:** Sitzkissen aus formstabilem Polyurethan differenzierter Dichte und Polyesterfaser; Rückenkissen aus in Kammern gesteppten Federn und einem formstabilen Polyurethankern. Die optionalen Armlehnkissen haben eine komplette Federfüllung. Alle Polster sind mit einem weißen Schonbezug verkleidet.

**SEZIONE SECTION SEKTION**

- 1:** Poliuretano a densità differenziata. Differentiated density polyurethane. Polyurethan differenzierter Dichte.
- 2:** Poliuretano. Polyurethane. Polyurethan.
- 3:** Fibra Poliestere. Polyester Fibre. Polyesterfaser.
- 4:** Fusto in legno massello e multistrato. Frame in solid wood and plywood. Korpus aus Massivholz, und schichtverleimt.
- 5:** Velfodera. Velfodera. Velfodera.

- 6:** Fodera in tela. Fabric lining. Schonbezug.
- 7:** Inserto in Poliuretano. Polyurethane insert. Kern aus Polyurethan.
- 8:** Fodera in tessuto antipiuma. Featherproof fabric cover. Federundurchlässiger Bezug des Kisseninlets.
- 9:** Piuma. Feathers. Federfüllung.
- 10:** Meccanismo in metallo. Metal mechanism. Metallmechanismus.

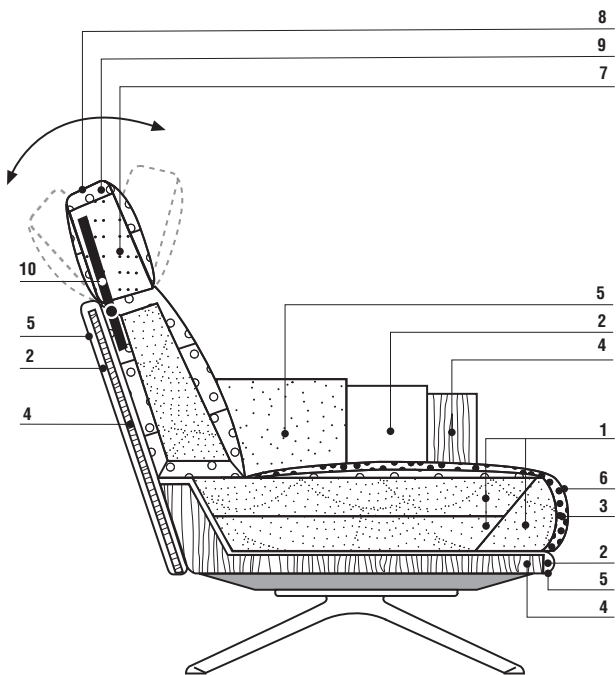

**VERSIONE ALTA**

**PIEDE FOOT FUSS**

Fusione di alluminio verniciato color bronzo. Bronzed painted aluminium cast. Aluminiumguss bronzefarben.

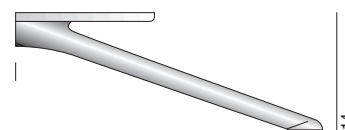

**BASE POLTRONA GIREVOLE E POUF  
BASE FOR SWIVEL ARMCHAIR AND POUF  
UNTERGESTELL DREHSELSEL UND HOCKER**

Fusione di alluminio verniciato color bronzo. Bronzed painted aluminium cast. Aluminiumguss bronzefarben.

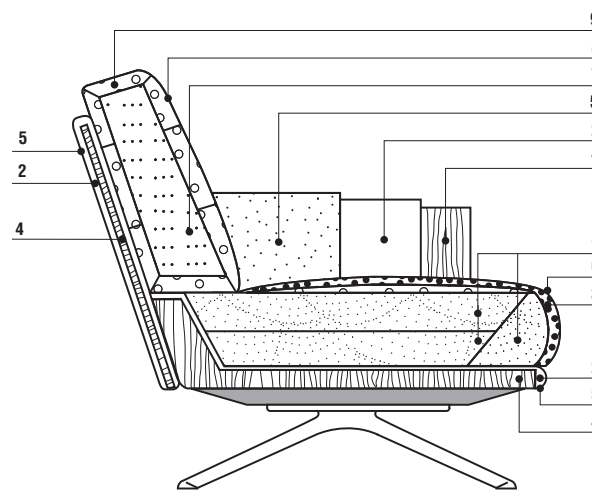
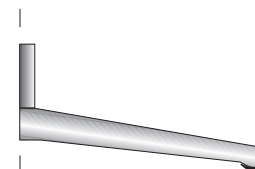

**VERSIONE BASSA**

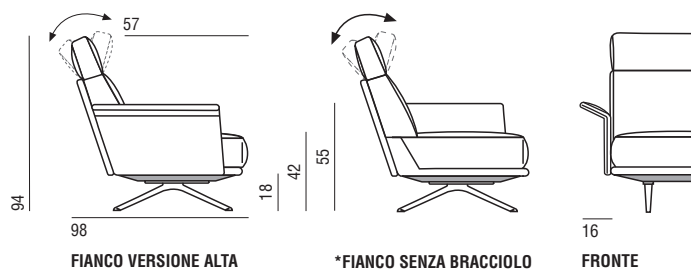

FIANCO VERSIONE ALTA

\*FIANCO SENZA BRACCIOLO

FRONTE

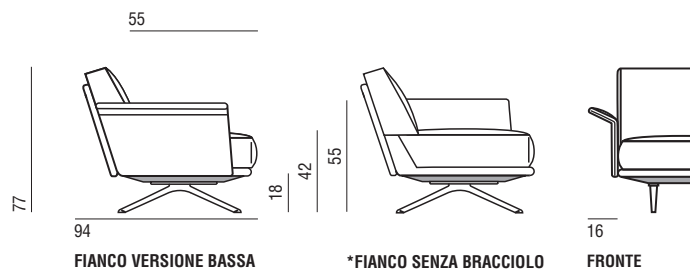

FIANCO VERSIONE BASSA

\*FIANCO SENZA BRACCIOLO

FRONTE

**NILSON ALTO**

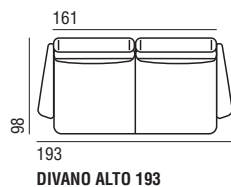

DIVANO ALTO 193

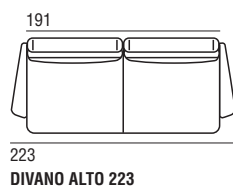

DIVANO ALTO 223

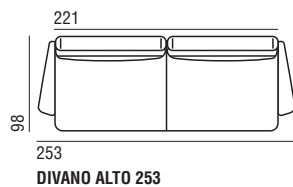

DIVANO ALTO 253

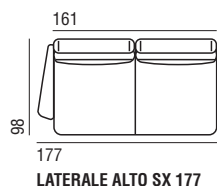

LATERALE ALTO SX 177



LATERALE ALTO DX 177

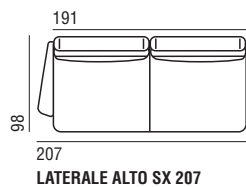

LATERALE ALTO SX 207

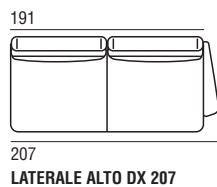

LATERALE ALTO DX 207

**NILSON BASSO**

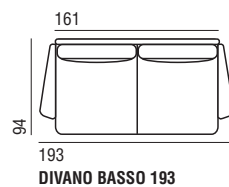

DIVANO BASSO 193

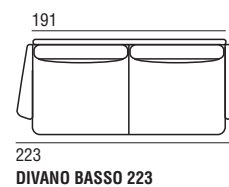

DIVANO BASSO 223

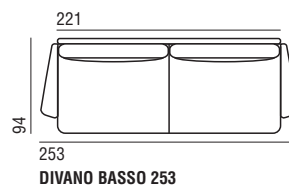

DIVANO BASSO 253

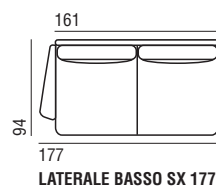

LATERALE BASSO SX 177

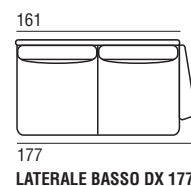

LATERALE BASSO DX 177

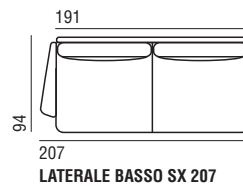

LATERALE BASSO SX 207

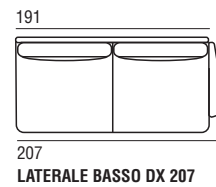

LATERALE BASSO DX 207

\*FIANCO SENZA BRACCIOLO PROGETTATO SOLO PER ESSERE ACCOSTATO AD ALTRI MODULI.  
SIDE WITHOUT ARMREST; DESIGNED TO BE MATCHED WITH OTHER MODULES.  
SEITE OHNE ARMLEHNE; NUR ZUM ANBAU AN ANDERE MODULE ENTWORFEN.

**NILSON ALTO**

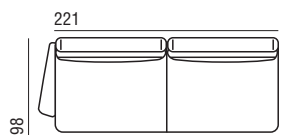

237  
**LATERALE ALTO SX 237**

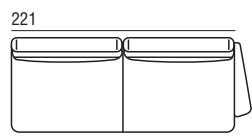

237  
**LATERALE ALTO DX 237**

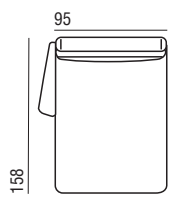

111  
**CHAISE LONGUE ALTA SX**

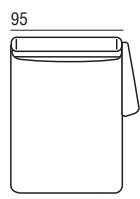

111  
**CHAISE LONGUE ALTA DX**

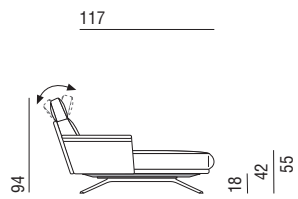

158  
**FIANCO CHAISE LONGUE ALTA**

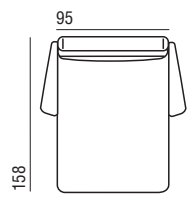

127  
**POLTRONA LUNGA ALTA**

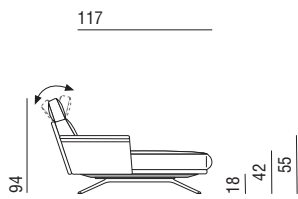

158  
**FIANCO POLTRONA LUNGA ALTA**

**NILSON BASSO**

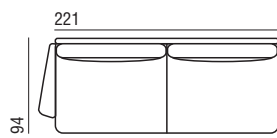

237  
**LATERALE BASSO SX 237**

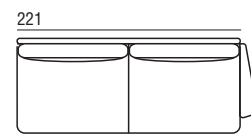

237  
**LATERALE BASSO DX 237**

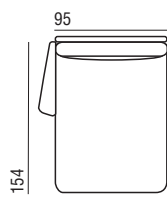

111  
**CHAISE LONGUE BASSA SX**

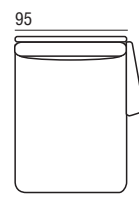

111  
**CHAISE LONGUE BASSA DX**

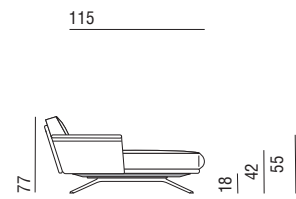

154  
**FIANCO CHAISE LONGUE BASSA**

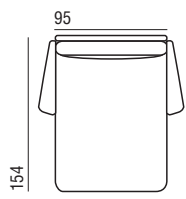

127  
**POLTRONA LUNGA BASSA**

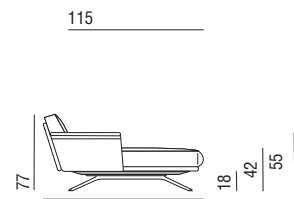

154  
**FIANCO POLTRONA LUNGA BASSA**

**NILSON ALTO**

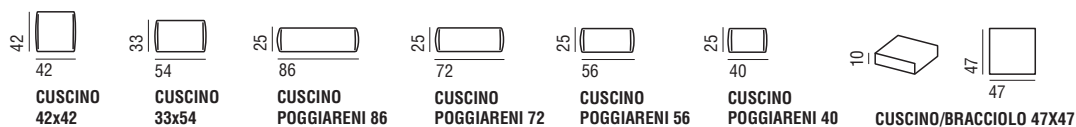
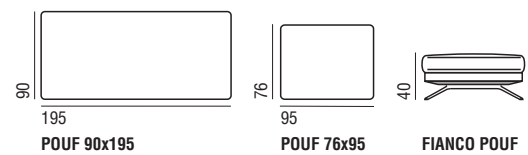
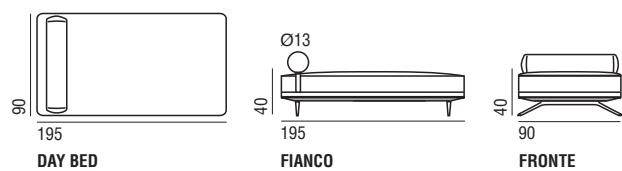
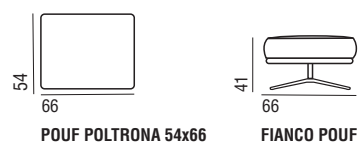
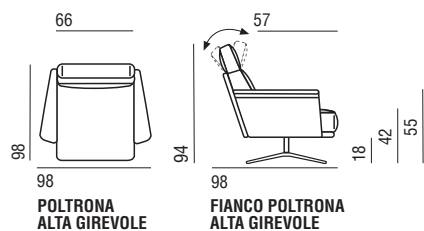

**NILSON BASSO**

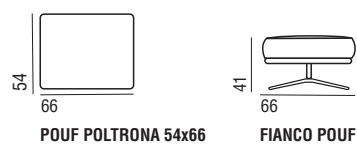
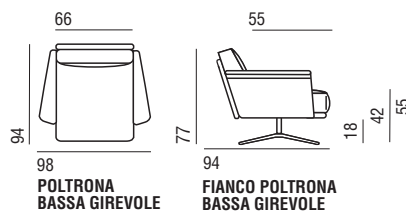



**Caratteristiche:** A completamento della collezione Nilson è disponibile la poltrona Lounge, completa di pouf, che, nonostante le ridotte dimensioni, offre una elevata comodità grazie alla base basculante, oltre che girevole e con ritorno automatico. È completamente sfoderabile. **Struttura:** Fusto in metallo, braccioli in multistrato curvato, imbottitura in poliuretano espanso indeformabile a densità differenziata, priverivestimento in tela accoppiata con fibra poliestere e Velfodera. Base a 4 razze in fusione d'alluminio verniciato color bronzo con meccanismo basculante, girevole e con ritorno automatico.

**Features:** The lounge armchair, with its pouf, completes the Nilson collection. Despite its reduced dimension, offers a high level of comfort thanks to the tilting as well as swiveling base with automatic return. Covers are completely removable. **Framework:** Metal frame, armrests in curved plywood, padding in non-deformable expanded polyurethane with differentiated densities. Lining in canvas coupled with polyester fiber and Velfodera. Four-legged base in bronzed painted aluminium cast with tilting and swiveling mechanism, with automatic return.

**Eigenschaften:** Der Sessel Lounge vervollständigt mit seinem dazu gehörigen Hocker die Kollektion Nilson. Trotz seiner reduzierten Maße bietet er gehobenen Komfort, auch dank seines Schwing- und Drehmechanismus mit Rückdrehautomatik. Die Bezüge sind vollständig abnehmbar. **Struktur:** Metallrahmen, Armlehnen in gebogenem Schichtholz, Polsterung aus formbeständigem Polyurethan mit differenzierten Dichten, Schonbezug mit Polyesterfaser und Velfodera. Vierstrahliges Untergestell aus bronzefarben lackiertem Aluminiumguss mit Schwing- und Drehmechanismus mit Rückholautomatik.

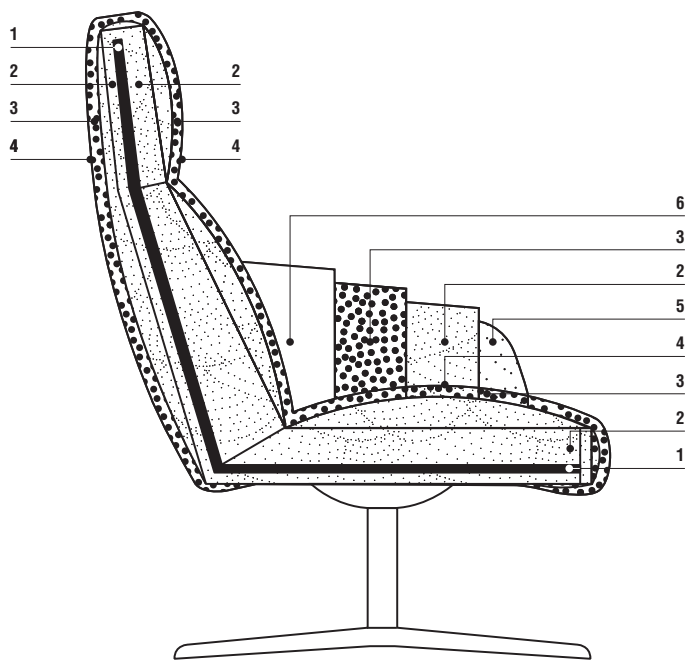

#### SEZIONE SECTION SEKTION

- 1: Telaio in metallo. Metal frame.  
Metallrahmen.
- 2: Poliuretano a densità differenziata.  
Polyurethan differenzierter Dichten.
- 3: Fibra poliestere. Polyester Fibre.  
Polyesterfaser.
- 4: Fodera in tela. Fabric lining. Schonbezug.
- 5: Multistrato curvato. Curved plywood.  
Gebogenes Schichtholz.
- 6: Velfodera. Velfodera. Velfodera.

#### BASE GIREVOLE, CON RITORNO AUTOMATICO, E BASCULANTE BASE WITH TILTING AND SWIVELING MECHANISM WITH AUTOMATIC RETURN. UNTERGESTELL MIT SCHWING- UND DREHMECHANISMUS MIT RÜCKDREHAUTOMATIK

Fusione di alluminio verniciato color bronzo.  
Bronzed painted aluminium cast.  
Aluminiumguss bronzefarben.

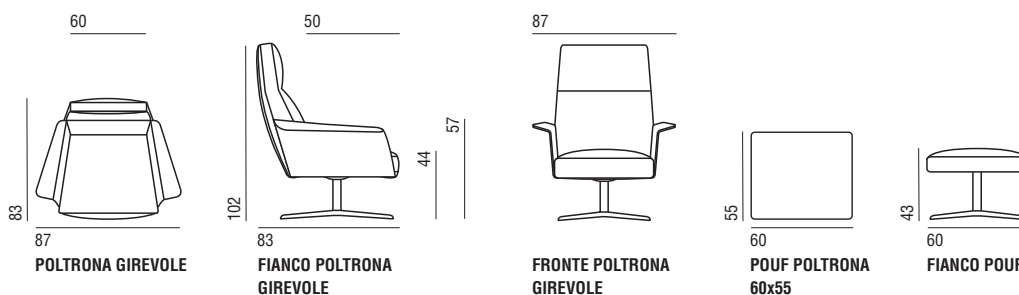
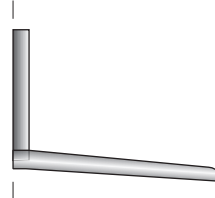



**Caratteristiche:** Sistema di sedute dalla linea solida ed essenziale; alto da terra, è caratterizzato da un piede a ponte in fusione di alluminio che gli conferisce leggerezza e dinamismo. Un bordino nello stesso tessuto del rivestimento scelto aggiunge un tocco di eleganza al modello. Un elemento distintivo importante è dato dalla possibilità di scegliere tra due diverse misure di bracciolo, uno di spessore cm. 25 e uno di spessore cm. 15. Le diverse dimensioni dei braccioli permettono di realizzare differenti configurazioni estetiche e, con il bracciolo da cm. 15, a parità di larghezza di seduta, ottenere un minore ingombro esterno. Divani, laterali, laterali angoli, dormeuse e chaise longue sono disponibili sia con i braccioli da cm. 25 che con i braccioli da cm. 15. I rimanenti moduli in collezione quali elementi, angoli, terminali e dormeuse angolo si possono accostare a entrambe le tipologie di bracciolo. Pouf in diverse misure completano il sistema. Irving offre inoltre la possibilità di scegliere fra due differenti versioni di schienale: con schienali rettangolari (tipo "A") o con cuscini-schienale (tipo "B" cm. 57x53) in quantità predefinita. Per permettere una maggiore personalizzazione Irving si può realizzare anche nella versione "BASE" (senza cuscini-schienale) da completare con i cuscini-schienale scelti fra quelli proposti in collezione. È disponibile un comodo poggiatesta formato da una struttura rivestita in rigenerato di fibre di cuoio color testa di moro, tagliato e cucito al vivo, e da un cuscino regolabile in altezza grazie a dei magneti. Il cuscino si può rivestire in tessuto o pelle. Nella versione con il bracciolo da cm. 25 è disponibile un comodo piano d'appoggio in cuoio color naturale o testa di moro. Irving si può inoltre attrezzare con i tavolini della serie Club. Il rivestimento è completamente sfoderabile ad eccezione della versione in pelle. **Struttura:** Fusto in legno massello e multistrato, imbottito in poliuretano espanso indeformabile a densità differenziata, molleggio con nastri elastici intrecciati. Prerivestimento con tela di cotone accoppiata con fibra poliestere. Piede a ponte di serie in fusione di alluminio verniciato color bronzo oppure, su richiesta, in fusione di alluminio lucidato. **Imbottiture cuscini:** Cuscini di seduta in poliuretano espanso indeformabile a densità differenziata e fibra poliestere. Cuscini-schienale tipo "A" in piuma canalizzata con inserto in poliuretano; cuscini-schienale tipo B (cm. 57x53) sono interamente in piuma canalizzata. Cuscini decorativi e poggiatesta opzionali sono completamente in piuma. Tutte le imbottiture sono interamente prerivestite con tela bianca.

**Features:** Seating system distinguished by a solid and essential line; high from the ground, characterized by a bridge-shaped foot in aluminium cast that confers lightness and dynamism. A piping in the same fabric chosen for the cover gives a touch of elegance to the model. An important hallmark for this collection is the possibility to choose between two different sizes of armrest, one it's 25 cm thick and one it's 15 cm thick. The two alternatives in the armrest width allow different options of esthetic configurations. Thanks to the 15 cm thick armrest it is possible to create sectionals, with the same seat width, but in a reduced overall space. Sofas, side pieces, side corners, dormeuse and chaise longue are available with both armrests: 25 cm as well as with 15 cm. The remaining modules of the collection such as elements, corners, end pieces and corner dormeuse can be combined with both kinds of armrest. Pouf in different sizes complete the system. Irving offers the possibility to choose between two backrest versions: with rectangular backrests (type "A") or with backrest-cushions (type "B" 57x53 cm) in a predefined quantity. Irving is also available in the "BASE" version (without backrest cushions) to be equipped and completed with backrest cushions selected among those available in the collection. It is available a comfortable headrest consisting of a frame, covered in dark brown regenerated leather fibers with visible cut and sewing, and a cushion. Cushion is adjustable in the height thanks to magnets and can be upholstered either in fabric or in leather. For the 25 cm armrest a comfortable plate in leather in natural color or dark brown shade is available. Irving can be also equipped with the series Club table. The cover can be completely and easily removed with the exception of the leather cover. **Framework:** Frame made of solid and plywood, padded with non-deformable expanded polyurethane of differentiated density, and sprung with interwoven elastic belts. Cotton lining coupled with polyester fibre. Bridge-shaped feet in bronzed painted aluminium cast as standard, or in polished aluminium cast upon request. **Cushion padding:** Seat cushions in non-deformable expanded polyurethane with differentiated densities, and polyester fibre. Backrest-cushions type "A" with canalised feather and polyurethane insert; backrest-cushions type "B" entirely made with canalised feather. Optional cushions and lumbar-cushions are entirely in feather. All padding is fully lined with white fabric.

**Eigenschaften:** Das Modulsystem mit einer kompakten und essentiellen Linie, nicht bodennah, kennzeichnet ein brückenförmiger Fuß in Aluminiumguss, der ihm Leichtigkeit und Dynamismus verleiht. Ein Keder des gleichen Stoffes, wie für das Sofa gewählt, ergänzt die Eleganz des Modells. Ein wichtiges Unterscheidungselement liegt in der Möglichkeit, zwischen zwei verschiedenen Armlehnbreiten, entweder 25 cm oder 15 cm, zu wählen. Die unterschiedlichen Armlehnbreiten erlauben verschiedene ästhetische Kompositionen und mit einer 15 cm breiten Armlehne einen geringeren Raumbedarf ohne Sitzflächeneinbuße. Sofas, Seitenteile, Seiteneckelemente, Dormeuse und Chaiselongue sind sowohl mit den 25 cm breiten als auch mit den 15 cm breiten Armlehnen erhältlich. Die restlichen Module wie Zentralelemente, Eckelemente, Endelemente und Eckdormeuse können an beide Armlehtypen gestellt werden. Hocker in verschiedenen Größen vervollständigen das System. Irving bietet auch die Möglichkeit zwischen zwei unterschiedlichen Rückenkissen zu wählen: traditionelle rechteckige Rückenkissen (Typ „A“) oder informelle Rückenkissen (Typ „B“ 57x53 cm) in vorbestimmter Anzahl. Eine individuelle Gestaltung des Modells Irving lässt sich mit der Version „Basis“ (d.h. ohne Rückenkissen) realisieren, die mit den in der Kollektion verfügbaren Rückenkissen frei vervollständigt werden kann. Die bequeme Kopfstütze aus dunkelbraunem Bonded Leder (mit „Steppnaht“) hat ein höhenverstellbares Nackenpolster, das durch Magneten an die Struktur gebunden ist und sowohl mit Stoff als auch mit Leder bezogen werden kann. Für die 25 cm breite Armlehne gibt es eine komfortable Armlehnenablage in hellbraunem oder dunkelbraunem Leder. Die Bezüge sind komplett abnehmbar, mit Ausnahme der Lederausführung. **Struktur:** Der Korpus besteht aus Massiv- und Mehrschichtholz, gepolstert mit formstabilem Polyurethan differenzierter Dichte und einer Federung mit geflochtenen elastischen Bändern. Unterbezug aus weißem Baumwollstoff mit Polyesterfaser. Brückenförmiger Fuß in bronzefarbenem Aluminiumguss serienmäßig oder, auf Anfrage, poliert. **Polster:** Sitzkissen aus formstabilem Polyurethan differenzierter Dichte und Polyesterfaser. Die Rückenkissenpolsterung Typ „A“ besteht aus in Kammern gesteppten Federn und einem formstabilen Polyurethankern. Rückenkissen Typ „B“ (57x53 cm) sind gänzlich aus in Kammern gesteppten Federn. Wurfkissen und Lendenkissen haben eine komplette Federfüllung. Alle Polster sind mit einem weißen Unterbezug verkleidet.

#### POGGIATESTA HEADREST KOPFSTÜTZE

- 1: Poliuretano. Polyurethane. Polyurethan.
- 2: Metallo rivestito in fibra di cuoio.  
Metal covered by leather fiber.  
Metall mit Bonded Leder bezogen.

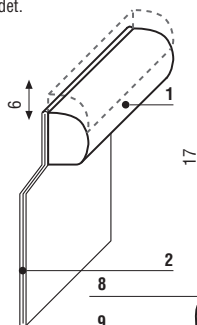

#### PIEDE FOOT FUSS

Fusione di alluminio verniciato color bronzo (di serie);  
fusione di alluminio lucidato (su richiesta).  
Bronze painted aluminium cast (series);  
polished cast aluminium (upon request).  
Standardausführung in bronzefarbenem Aluminiumguss;  
Auf Anfrage in Aluminiumguss poliert.

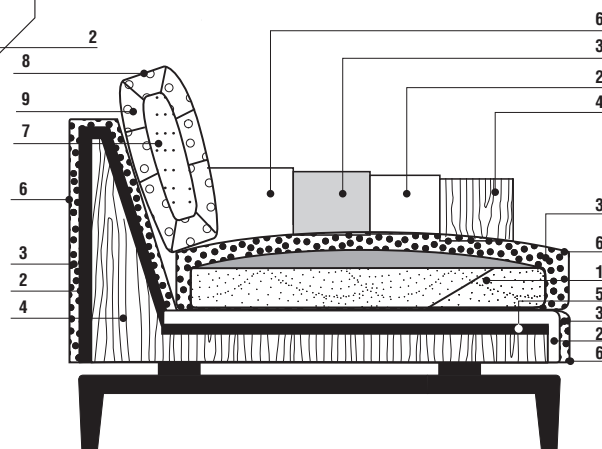
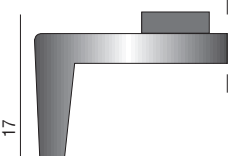

#### SEZIONE SECTION SEKTION

- 1: Poliuretano a densità differenziata.  
Differentiated density polyurethane.  
Polyurethan unterschiedlicher Dichte.
- 2: Poliuretano. Polyurethane. Polyurethan.
- 3: Fibra Poliestere. Polyester Fibrer.  
Polyesterfaser.
- 4: Fusto in legno massello e multistrato.  
Frame in solid wood and plywood.  
Korpus aus Massiv- und Mehrschichtholz.
- 5: Nastri elastici. Elastic belts. Elastische Gurte.
- 6: Fodera in tela. Fabric lining. Schonbezug.
- 7: Inserto in Poliuretano. Polyurethane insert.  
Kern aus Polyurethan.
- 8: Fodera in tessuto antipiuma.  
Featherproof fabric cover.  
Federnundurchlässiger Bezug des Kisseninlets.
- 9: Piuma. Down. Federfüllung.

**IRVING VERSIONE A**



**FIANCO**

**IRVING VERSIONE B**



**FIANCO**

**IRVING VERSIONE BASE**



**FIANCO**

**BRACCIOLIO 25 CM**

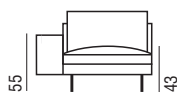

**FRONTE**

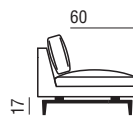

**SEZ. DEL FIANCO**

**BRACCIOLIO 15 CM**

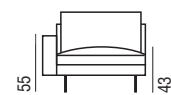

**FRONTE**



**SEZ. DEL FIANCO**

**IRVING MODULI CON BRACCIOLI 25 CM. VERSIONE A**

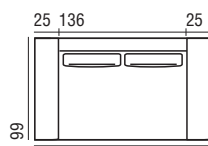

**DIVANO 186 - 25 A**  
cuscino unico

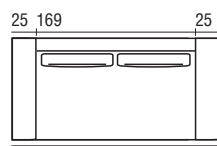

**DIVANO 219 - 25 A**  
cuscino unico

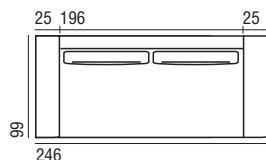

**DIVANO 246 - 25 A**  
cuscino unico

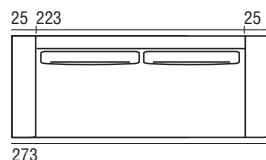

**DIVANO 273 - 25 A**  
cuscino unico

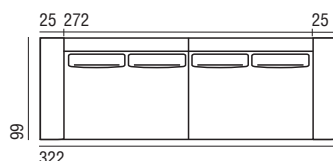

**DIVANO 322 - 25 A**  
composto da 2 laterali 161 SX e DX cuscini unici

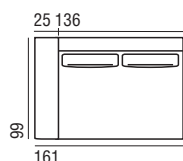

**LATERALE 161 - 25 A SX**  
cuscino unico

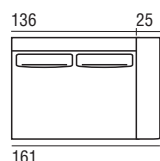

**LATERALE 161 - 25 A DX**  
cuscino unico

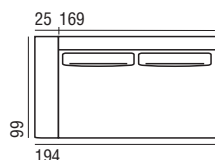

**LATERALE 194 - 25 A SX**  
cuscino unico

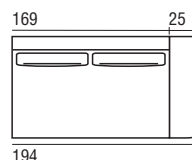

**LATERALE 194 - 25 A DX**  
cuscino unico

**IRVING MODULI CON BRACCIOLI 25 CM. VERSIONE B**

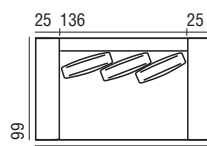

**DIVANO 186 - 25 B**  
cuscino unico

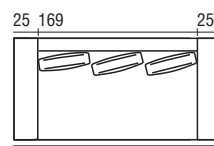

**DIVANO 219 - 25 B**  
cuscino unico

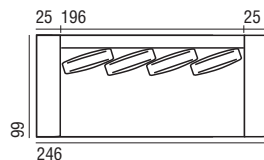

**DIVANO 246 - 25 B**  
cuscino unico

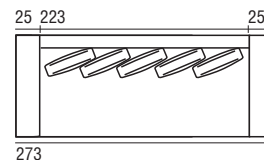

**DIVANO 273 - 25 B**  
cuscino unico

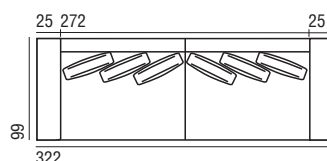

**DIVANO 322 - 25 B**  
composto da 2 laterali 161 SX e DX cuscini unici

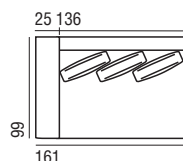

**LATERALE 161 - 25 B SX**  
cuscino unico

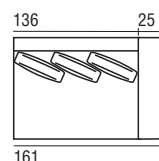

**LATERALE 161 - 25 B DX**  
cuscino unico

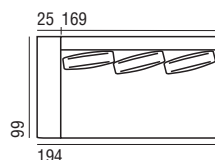

**LATERALE 194 - 25 B SX**  
cuscino unico

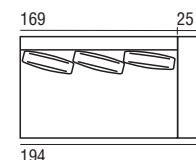

**LATERALE 194 - 25 B DX**  
cuscino unico

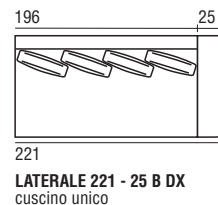
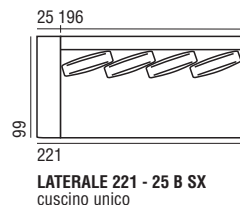
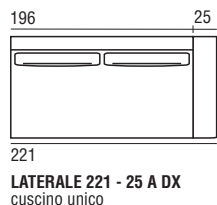
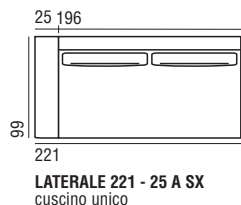

**IRVING MODULI CON BRACCIOLI 25 CM. VERSIONE A**

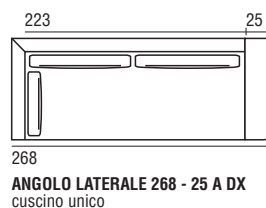
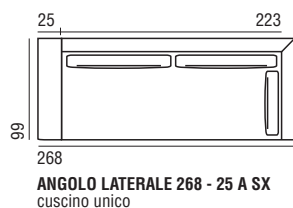
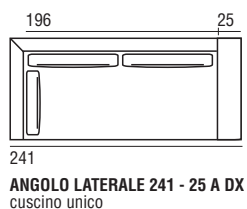
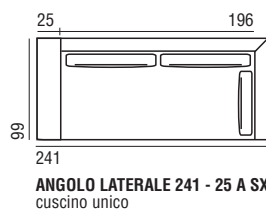
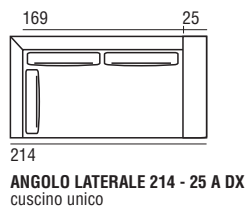
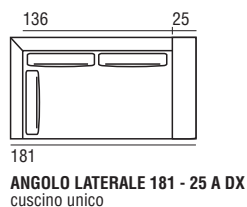
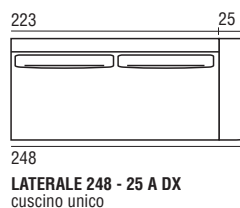
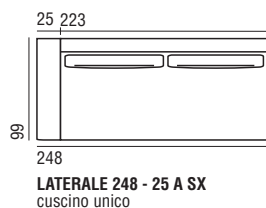

**IRVING MODULI CON BRACCIOLI 25 CM. VERSIONE B**

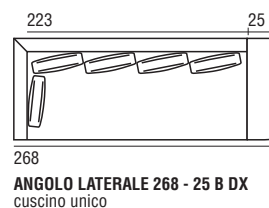
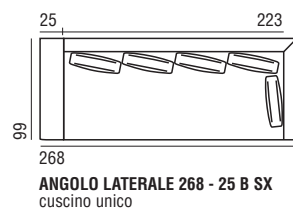
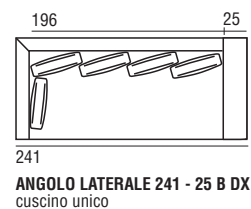
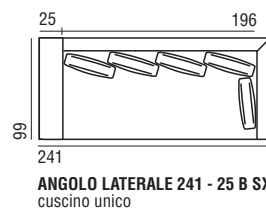
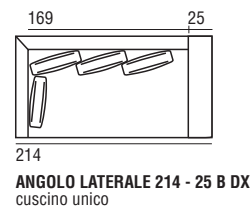
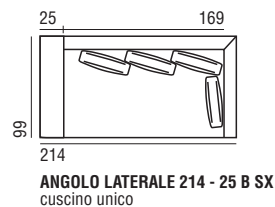
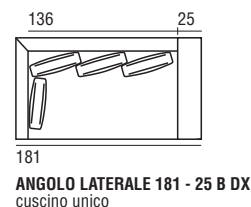
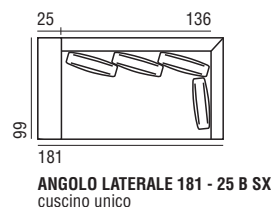
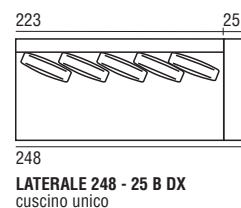
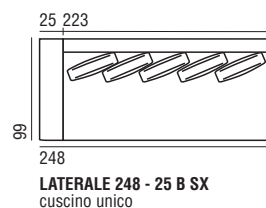



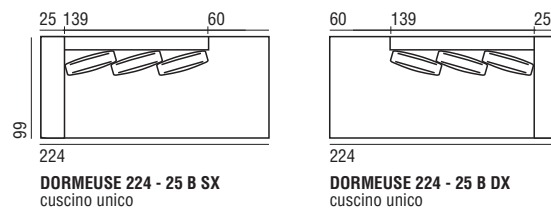
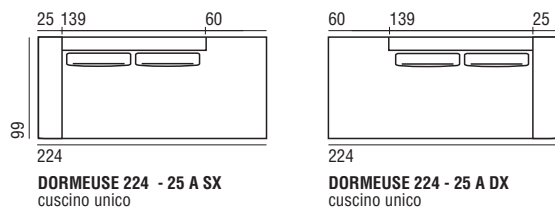

**IRVING MODULI CON BRACCIOLI 25 CM. VERSIONE A**

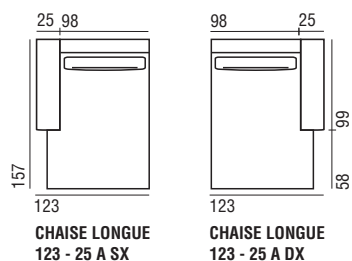

**IRVING MODULI CON BRACCIOLI 25 CM. VERSIONE B**

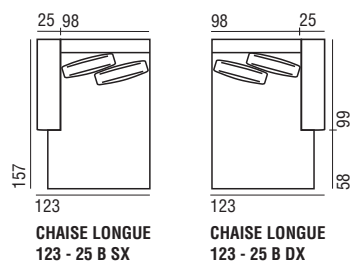

**IRVING MODULI CON BRACCIOLI 15 CM. VERSIONE A**

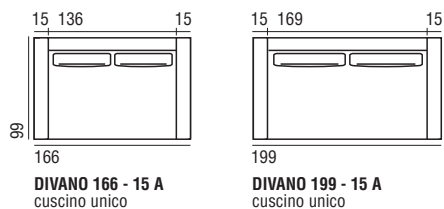

**IRVING MODULI CON BRACCIOLI 15 CM. VERSIONE B**

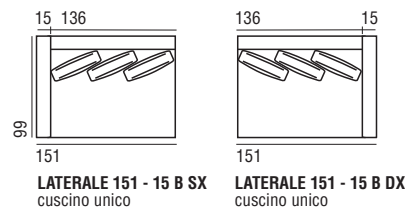
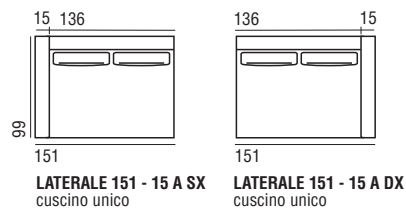
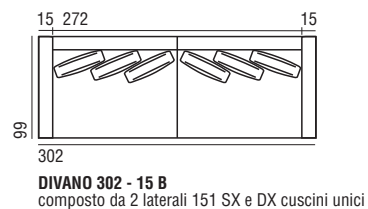
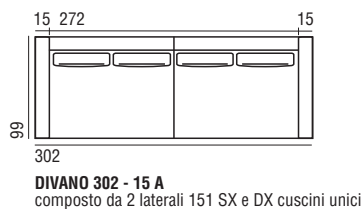
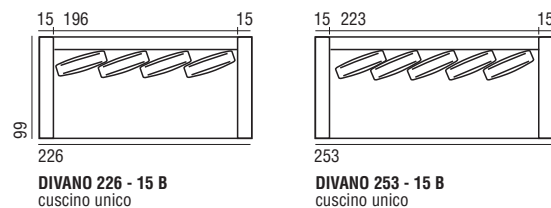
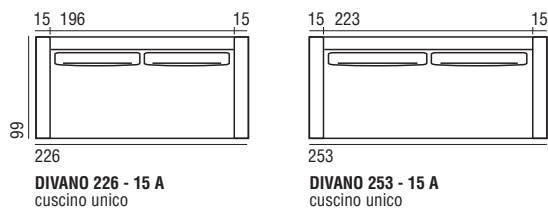
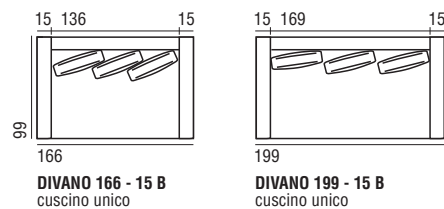

**IRVING MODULI CON BRACCIOLI 15 CM. VERSIONE A**

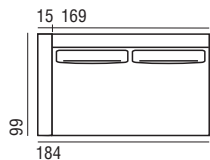

**LATERALE 184 - 15 A SX**  
cuscino unico

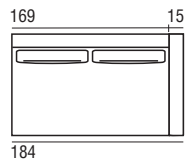

**LATERALE 184 - 15 A DX**  
cuscino unico

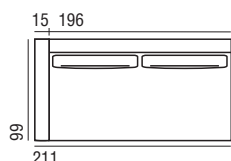

**LATERALE 211 - 15 A SX**  
cuscino unico

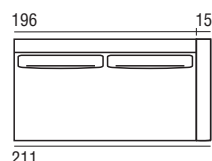

**LATERALE 211 - 15 A DX**  
cuscino unico

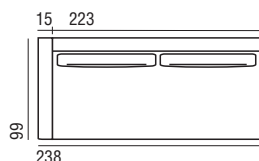

**LATERALE 238 - 15 A SX**  
cuscino unico

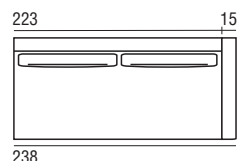

**LATERALE 238 - 15 A DX**  
cuscino unico

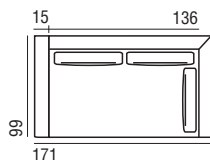

**ANGOLO LATERALE 171 - 15 A SX**  
cuscino unico

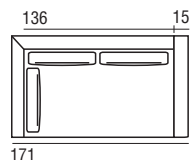

**ANGOLO LATERALE 171 - 15 A DX**  
cuscino unico

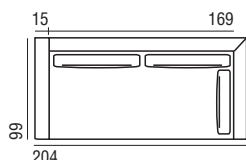

**ANGOLO LATERALE 204 - 15 A SX**  
cuscino unico

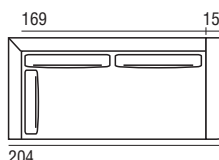

**ANGOLO LATERALE 204 - 15 A DX**  
cuscino unico

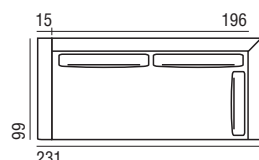

**ANGOLO LATERALE 231 - 15 A SX**  
cuscino unico

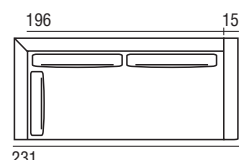

**ANGOLO LATERALE 231 - 15 A DX**  
cuscino unico

**IRVING MODULI CON BRACCIOLI 15 CM. VERSIONE B**

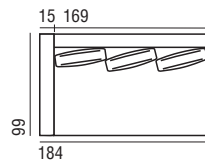

**LATERALE 184 - 15 B SX**  
cuscino unico

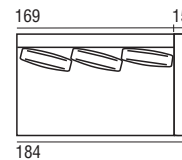

**LATERALE 184 - B 15 DX**  
cuscino unico

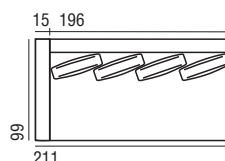

**LATERALE 211 - 15 B SX**  
cuscino unico

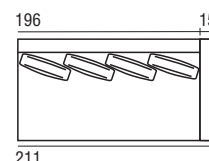

**LATERALE 211 - 15 B DX**  
cuscino unico

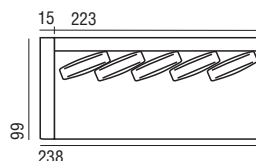

**LATERALE 238 - 15 B SX**  
cuscino unico

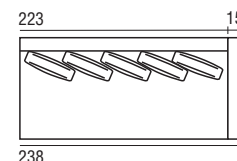

**LATERALE 238 - 15 B DX**  
cuscino unico

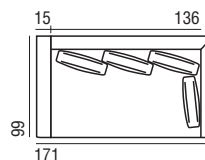

**ANGOLO LATERALE 171 - 15 B SX**  
cuscino unico

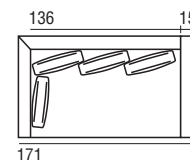

**ANGOLO LATERALE 171 - 15 B DX**  
cuscino unico

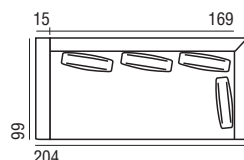

**ANGOLO LATERALE 204 - 15 B SX**  
cuscino unico

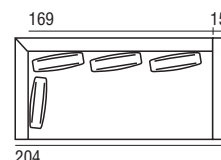

**ANGOLO LATERALE 204 - 15 B DX**  
cuscino unico

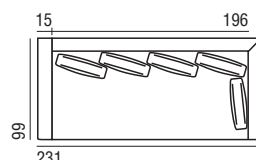

**ANGOLO LATERALE 231 - 15 B SX**  
cuscino unico

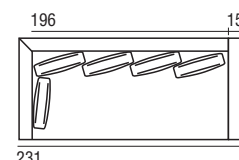

**ANGOLO LATERALE 231 - 15 B DX**  
cuscino unico

**IRVING MODULI CON BRACCIOLI 15 CM. VERSIONE A**

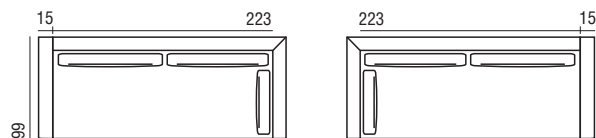

258  
**ANGOLO LATERALE 258 - 15 A SX**  
cuscino unico

258  
**ANGOLO LATERALE 258 - 15 A DX**  
cuscino unico

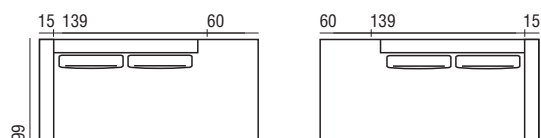

214  
**DORMEUSE 214 - 15 A SX**  
cuscino unico

214  
**DORMEUSE 214 - 15 A DX**  
cuscino unico

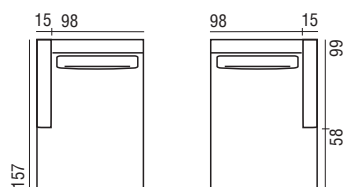

113  
**CHAISE LONGUE**  
113 - 15 A SX

113  
**CHAISE LONGUE**  
113 - 15 A DX

**IRVING MODULI CON BRACCIOLI 15 CM. VERSIONE B**

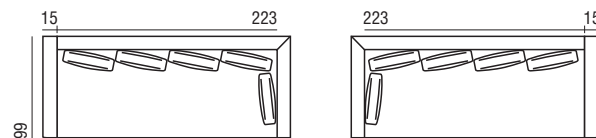

258  
**ANGOLO LATERALE 258 - 15 B SX**  
cuscino unico

258  
**ANGOLO LATERALE 258 - 15 B DX**  
cuscino unico

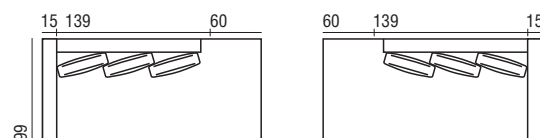

214  
**DORMEUSE 214 - 15 B SX**  
cuscino unico

214  
**DORMEUSE 214 - 15 B DX**  
cuscino unico

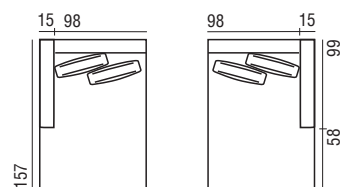

113  
**CHAISE LONGUE**  
113 - 15 B SX

113  
**CHAISE LONGUE**  
113 - 15 B DX

**IRVING MODULI SENZA BRACCIOLI VERSIONE A**

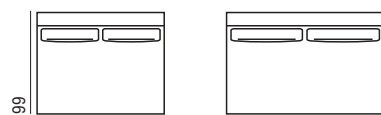

136  
**ELEMENTO 136 A**  
cuscino unico

169  
**ELEMENTO 169 A**  
cuscino unico

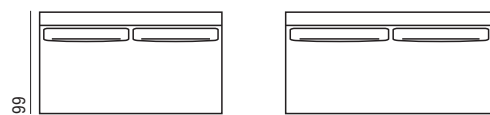

196  
**ELEMENTO 196 A**  
cuscino unico

223  
**ELEMENTO 223 A**  
cuscino unico

**IRVING MODULI SENZA BRACCIOLI VERSIONE B**

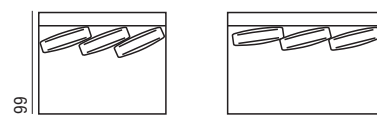

136  
**ELEMENTO 136 B**  
cuscino unico

169  
**ELEMENTO 169 B**  
cuscino unico

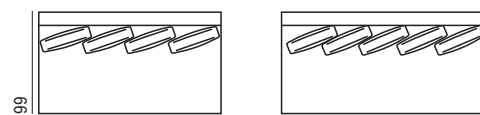

196  
**ELEMENTO 196 B**  
cuscino unico

223  
**ELEMENTO 223 B**  
cuscino unico

**IRVING MODULI SENZA BRACCIOLI VERSIONE A**

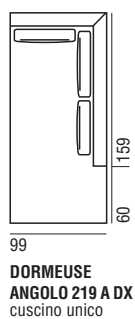
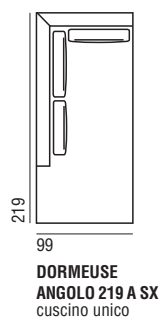
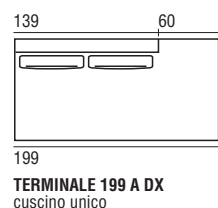
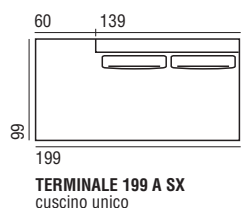
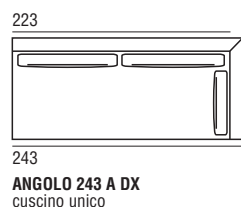
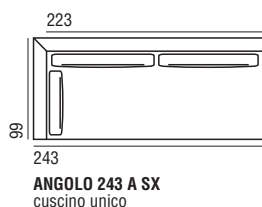
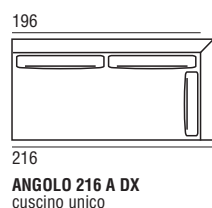
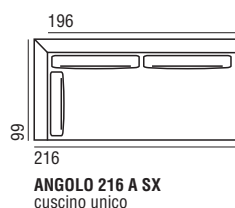
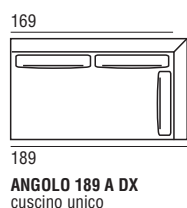
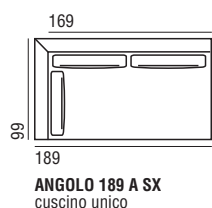
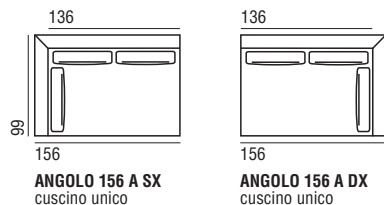

**IRVING MODULI SENZA BRACCIOLI VERSIONE B**

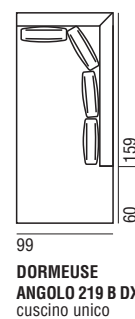
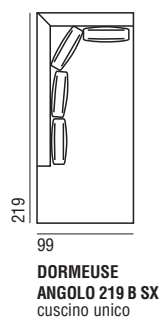
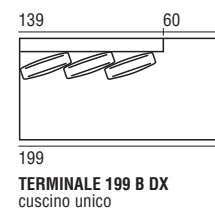
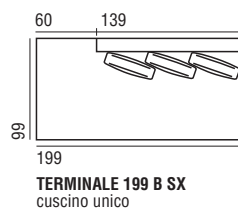
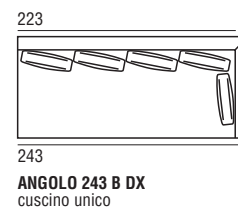
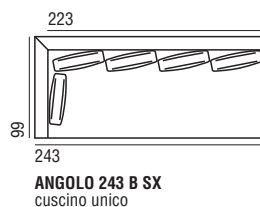
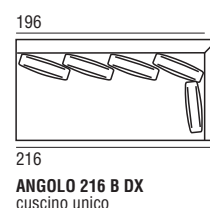
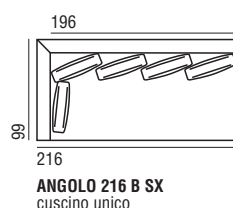
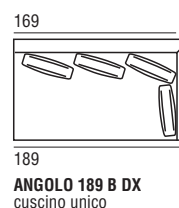
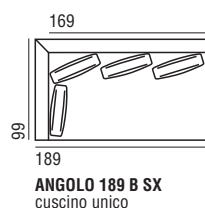
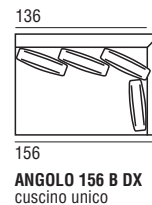
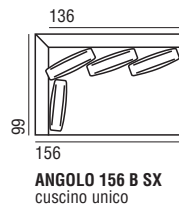



**FIANCO POUF**



**POUF 99x99**



**POUF 69x99**



**POUF 77x113**



**SCHIENALE  
65x61**



**SCHIENALE  
57x53**



**SCHIENALE  
48x44**



**CUSCINO  
42x42**



**CUSCINO  
54x33**

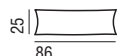

**CUSCINO  
POGGIARENI 86**

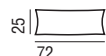

**CUSCINO  
POGGIARENI 72**



**CUSCINO  
POGGIARENI 56**



**CUSCINO  
POGGIARENI 40**

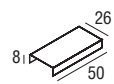

**PIANO APPOGGIO  
CUOIO**

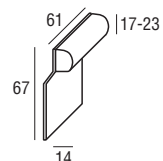

**POGGIATESTA**



**Caratteristiche:** La linea pulita della scocca, unita al piede a ponte in fusione di alluminio, conferiscono dinamismo e leggerezza al modello Larsen, mentre le accoglienti e comode imbottiture donano morbidezza per un risultato di grande eleganza che rimanda ai modelli americani anni '60. La collezione Larsen comprende divani e pouf in diverse misure oltre a moduli componibili quali elementi, laterali, angoli, terminali, chaise longue, dormeuse, dormeuse angolo e un confortevole day bed. Una poltrona di dimensioni contenute completa la gamma. Comodi poggiatesta e cuscini decorativi in diverse misure sono disponibili come optional. I divani si forniscono, di serie, con i cuscini di seduta divisi e, su richiesta, con i cuscini di seduta unici, mentre i moduli componibili si forniscono con i cuscini di seduta unici. La chaise longue e la dormeuse angolo sono disponibili con schienali rettangolari (tipo A) oppure con cuscini-schienale tipo B (da cm.60x60). Il rivestimento in tessuto è completamente sfoderabile. Larsen è attrezzabile con i tavolini Argo e Jim. **Struttura:** Fusto in legno massello e multistrato, imbottito in poliuretano espanso indeformabile a densità differenziata, molleggio con nastri elastici intrecciati. Prerivestimento con tela di cotone accoppiata con fibra poliestere. Piede a ponte di serie in fusione di alluminio verniciato color bronzo oppure, su richiesta, in versione lucidata. **Imbottitura:** Cuscini di seduta in poliuretano espanso indeformabile a densità differenziata e fibra poliestere. Su richiesta, con supplemento di prezzo, si forniscono i cuscini di seduta nella versione in piuma canalizzata con inserto in poliuretano a densità differenziata. I cuscini-schienale sono in fibra poliestere cardata, canalizzata, con inserto in poliuretano espanso indeformabile; i cuscini-schienale tipo B (cm. 60x60) - disponibili esclusivamente nella chaise longue e nella dormeuse-angolo - sono interamente in piuma canalizzata. I cuscini decorativi e i poggiatesta opzionali sono interamente in piuma. Il Cuscino Rollo per Day bed è in poliuretano e fibra. Tutte le imbottiture sono prerivestite con tela bianca.

**Features:** The essential design of the frame together with the bridge-shaped feet in aluminium cast give dynamism and lightness to the item Larsen, while comfortable padding lends softness for an elegant result recalling the American models of the '60s. Collection Larsen includes sofas and poufs available in different dimensions, beside sectional modules like elements, side pieces, corners, end pieces, chaise longue, dormeuse, corner dormeuse and a comfortable day bed. A small armchair completes the range. Comfortable lumbar cushions and cushions are available in various sizes as optional. The sofas are provided as standard, with divided seat cushions and, on request, with one unique seat cushion only; while the modular units are provided with one unique seat cushion only. Sofas are delivered with divided seat cushions, while sectional modules are delivered with unique seat cushion. Chaise Longue and Corner Dormeuse are available either with rectangular backrest cushions (type A) or with square backrest cushions type B (cm 60x60). Fabric cover is fully removable. Larsen can be equipped with tables: Argo and Jim. **Structure:** Fusto in legno massello e multistrato, imbottito in poliuretano espanso indeformabile a densità differenziata, molleggio con nastri elastici intrecciati. Prerivestimento con tela di cotone accoppiata con fibra poliestere. Piede a ponte di serie in fusione di alluminio verniciato color bronzo oppure, su richiesta, in versione lucidata. **Cushion padding:** Seat cushions in non-deformable expanded polyurethane with differentiated density and polyester fibre. Upon request, and with up charge, seat cushions with canalised feather and polyurethane insert can be provided. Backrest-Cushions in teased and canalised polyester fibre with non-deformable polyurethane insert. Backrest-Cushions type B (cm 60x60) -available by chaise longue and corner dormeuse only- are fully in canalised feather. Optional cushions and lumbar-cushions are entirely in feather. Roll cushion for Day bed is in polyurethane and polyester fibre. All padding is fully lined with white fabric.

**Eigenschaften:** Minimalistische Linien des Korpus, verbunden mit dem brückenförmigen Fuß in Aluminiumguss, verleihen dem Modell Larsen Dynamismus und Leichtigkeit, während die einladenden und bequemen Polster Weichheit schenken. Das Resultat ist eine hohe Eleganz, die an die amerikanischen Modelle der 60er Jahre erinnert. Die Kollektion Larsen bietet Sofas und Hocker verschiedener Maße und, abgesehen von Zentralelementen, Seitenteilen, Eckteilen, Endelementen, Chaiselongue, Dormeuse, Eckdormeuse, auch ein komfortables Daybed. Ein kleiner Sessel vervollständigt das Angebot. Bequeme Lenden- und Wurfkissen verschiedener Größen sind optional. Die Sitzkissen der Einzelsofas sind serienmäßig immer geteilt (auf Anfrage jedoch auch durchgehend erhältlich), die der Module jedoch durchgehend. Sowohl die Chaiselongue als auch die Eckdormeuse sind mit rechteckigen Rückenkissen (Typ A) verfügbar oder mit den großen viereckigen Rückenkissen (Typ B 60x60 cm). Stoffbezüge sind komplett abziehbar. Dem Modell Larsen können die Tische Argo und Jim beigeestellt werden. **Struktur:** Der Korpus besteht aus Massiv- und Mehrschichtholz, gepolstert mit formstabilem Polyurethan unterschiedlicher Dichte und einer Federung mit geflochtenen elastischen Bändern. Schonbezug aus weißem Baumwollstoff mit Polyesterfaser. Brückenförmiger Fuß in bronzefarbenen Aluminiumguss serienmäßig oder, auf Anfrage, poliert. **Polster:** Sitzkissen aus formstabilem Polyurethan unterschiedlicher Dichte und Polyesterfaser. Auf Anfrage, und unter Anrechnung eines Aufpreises, können die Sitzkissen mit Federn, in Kammern gesteppt, und einem Polyurethankern unterschiedlicher Dichte geliefert werden. Die Rückenkissenpolsterung ist aus gekämmter und in Kammern gesteppter Polyesterfaser mit einem formstabilen Polyurethankern. Die Rückenkissenfüllung, Version B (cm 60x60), - nur bei der Chaiselongue und der Eckdormeuse erhältlich - ist gänzlich aus in Kammern gesteppten Federn. Die optionalen Wurf- und Lendenkissen haben eine reine Federfüllung. Die Nackenrolle des Daybeds ist in Polyurethan und Polyesterfaser. Alle Polster sind mit einem weißen Schonbezug verkleidet.

**PIEDE FOOT FUB**

Fusione di alluminio verniciato color bronzo (di serie);  
 fusione di alluminio lucidato (su richiesta).  
 Bronze painted aluminium cast (series);  
 polished cast aluminium (upon request).  
 Standardausführung in bronzefarbenen Aluminiumguss;  
 Auf Anfrage in Aluminiumguss poliert.

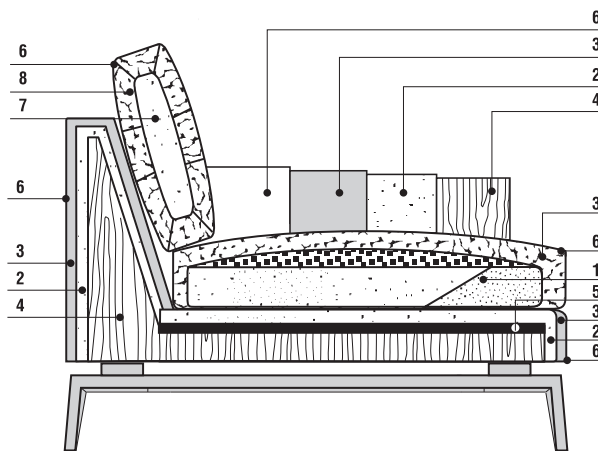
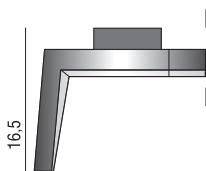

**SEZIONE SECTION SEKTION**

- 1: Poliuretano a densità differenziata.  
Differentiated density polyurethane.  
Polyurethan unterschiedlicher Dichte.
- 2: Poliuretano. Polyurethane. Polyurethan.
- 3: Fibra Poliestere. Polyester Fibre.  
Polyesterfaser.
- 4: Fusto in legno massello e multistrato.  
Frame in solid wood and plywood.  
Korpus aus Massivholz, und schichtverleimt.
- 5: Nastri elastici. Elastic belts. Elastische Gurte.
- 6: Fodera in tela. Fabric lining. Schonbezug.
- 7: Inserto in Poliuretano. Polyurethane insert.  
Kern aus Polyurethan.
- 8: Fibra Poliestere cardata, canalizzata.  
Teased and canalised polyester fibre.  
Gekämmte, in Kammern gesteppte Polyesterfaser.

**LARSEN VERSIONE A**

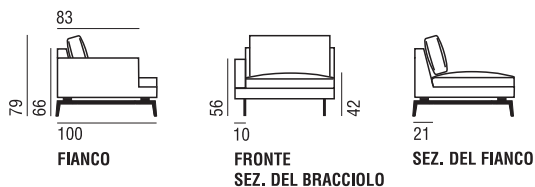

**LARSEN VERSIONE B**

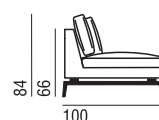

**SEZ. DEL FIANCO DELLA VERSIONE B  
 (RIFERITA ALLA SOLA CHAISE LONGUE E DORMEUSE ANGOLO)**



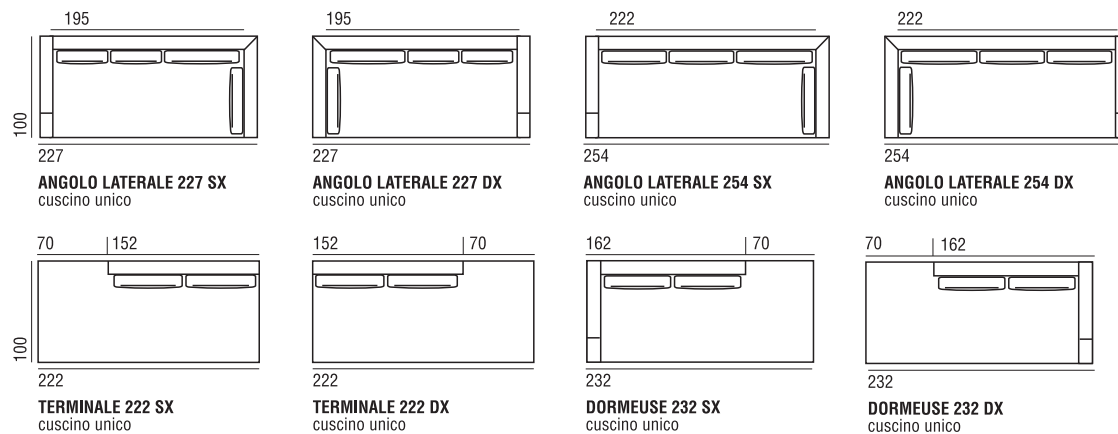

**LARSEN VERSIONE A**

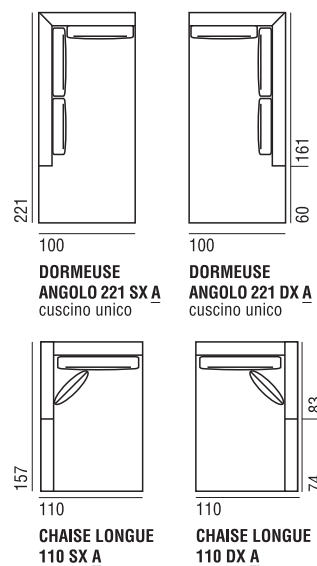

**LARSEN VERSIONE B**

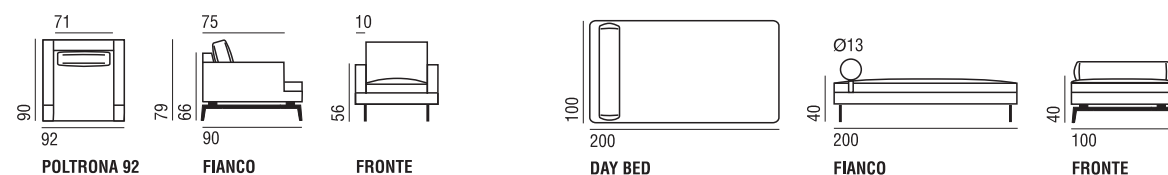
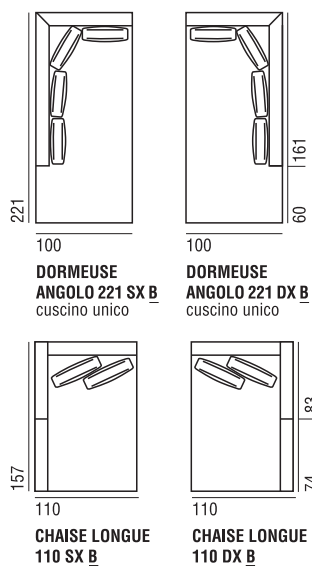



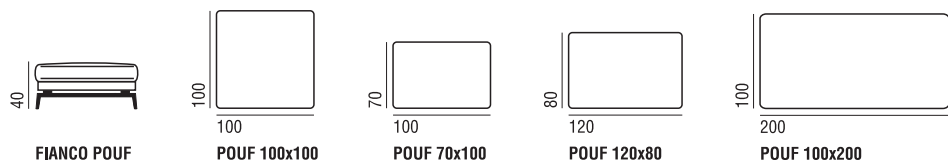



**Caratteristiche:** Divanitas è la riedizione di un modello disegnato da Alberto Lievore & Asociados e realizzato da Verzelloni nel 1996. Il modello, che conserva la linea innovativa, sinuosa ed essenziale, della prima edizione, è stato rivisitato nelle proporzioni e nel comfort di seduta e schienale per meglio rispondere alle attuali esigenze abitative. La ridotta profondità rende Divanitas adatto a spazi e ambienti di dimensioni contenute. La collezione comprende tre diverse misure di divani, una poltrona bassa, una poltrona alta e un pouf. A seconda del rivestimento scelto, la fodera si realizza in due diverse finiture: con cucitura ribattuta semplice o con "Punto Cavallo" (vedi sotto). Il "Punto Cavallo" è un'impuntura decorativa disponibile in 11 colori (vedi retrocopertina listino prezzi) da abbinare a piacere ai tessuti dichiarati idonei per questa finitura. Il "Punto Cavallo" si fornisce con supplemento di prezzo. Il rivestimento è completamente sfoderabile ad eccezione della versione in pelle. **Versione Pelle:** La versione in pelle differisce da quella in tessuto. Sulla parte interna del bracciolo si esegue una cucitura diagonale. **Struttura:** Fusto in legno massello e multistrato, molleggio con nastri elastici intrecciati. Il piede, di serie, è in fusione di alluminio verniciato color bronzo oppure, su richiesta e con supplemento di prezzo, ricoperto in legno finitura rovere naturale o rovere moro. **Imbottiture:** In poliuretano espanso indeformabile a densità differenziata più fibra poliestere, prerinvolgimento in tela di cotone accoppiata con fibra poliestere.

**Features:** Divanitas is the new re-styling of a model designed by Alberto Lievore & Asociados and created by Verzelloni in 1996. The model preserves the innovative, sinuous and essential line of the first edition while it has been revised in the proportions and in the comfort of the seat and back to better meet the current housing needs. The reduced depth makes Divanitas suitable to small spaces and areas. The range includes three different sizes of sofas, an armchair available either with low or with high backrest and a pouf. Covers are completely and easily removable. According to the chosen fabric upholstery cover can be delivered in two different finishes: single lapped seam or with "Punto Cavallo" (see below). "Punto Cavallo" is a decorative stitching available in 11 colours (see back cover price list) to be matched at pleasure with the fabric. Fabric needs to be chosen among those specified as suitable for this finish. There is an up charge for the "Punto Cavallo" option. **Leather version:** The leather version differs from the fabric version. A diagonal seam is executed on the inside part of the armrest. **Framework:** Frame is in solid wood and plywood, sprung with interwoven elastic belts. The foot is in burnished cast aluminium series. Upon request and with up charge, wood covered natural oak or moor oak finish. **Padding:** Non-deformable differentiated density foamed polyurethane and polyester fibre; under-covering in cotton canvas coupled with polyester fibre.

**Eigenschaften:** Divanitas ist die Neuausgabe eines Modells, entworfen von Alberto Lievore & Asociados und von Verzelloni im Jahr 1996 realisiert. Das Modell, das die innovative, geschwungene und essentielle Linie der Erstausgabe bewahrt, ist in seinen Proportionen und seinem Sitzkomfort überarbeitet worden, um den heutigen Ansprüchen zu genügen. Dank der reduzierten Tiefe eignet sich das Divanitas für begrenzte Räumlichkeiten. Die Kollektion umfasst drei Sofas verschiedener Größen, einen Sessel mit niedriger Rückenlehne, einen Hochlehner und einen Hocker. Je nach Wahl des Stoffes, gibt es den Bezug in zwei unterschiedlichen Ausführungen: mit einfacher Kappnaht oder mit dem "Punto Cavallo" (siehe unten); ein Zierstich, der in 11 verschiedenen Farben bei den dafür geeigneten Stoffen realisiert werden kann (siehe Deckblatt Innenseite der Preisliste). Der "Punto Cavallo" ist mit Aufpreis erhältlich. Die Bezüge sind komplett abnehmbar, mit Ausnahme der Lederausführung. **Lederversion:** Die Lederversion unterscheidet sich von der Stoffversion. An der Innenseite der Armlehne wird eine diagonale Naht ausgeführt. **Struktur:** Der Rahmen besteht aus Massiv- und Mehrschichtholz und einer Federung mit geflochtenen elastischen Gurten. Der serienmäßige Fuß ist in Aluminiumguss in Bronzefarbe; auf Anfrage und mit Aufpreis furniert Eiche hell oder Eiche dunkel. **Polsterung:** Formstabile Polyurethan mit differenzierten Dichten plus Polyesterfaser. Unterbezug aus Baumwolle mit Polyesterfaser.

**PIEDE FOOT FUSS**

**Fusione** di alluminio verniciato color bronzo (di serie)  
 Ricoperto in legno finitura rovere naturale (con supplemento di prezzo)  
 Ricoperto in legno finitura rovere moro (con supplemento di prezzo)  
 Bronze painted aluminium cast (series)  
 Wood covered natural oak (with up charge)  
 Wood covered moor oak (with up charge)  
 Standardausführung in bronzefarbenem Aluminiumguss  
 Furnier Eiche hell (mit Aufpreis)  
 Furnier Eiche dunkel (mit Aufpreis)

**Cucitura ribattuta semplice;**  
 Single lapped seam;  
 einfache Kappnaht.

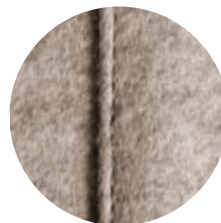

**Cucitura Punto Cavallo;**  
 Stitching Punto Cavallo;  
 Ziernaht Punto Cavallo.

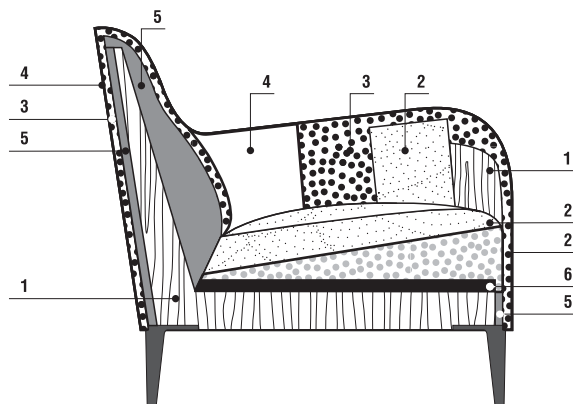
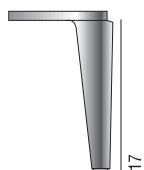
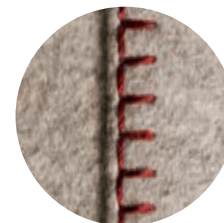

**SEZIONE SECTION SEKTION**

- 1:** Fusto in legno massello e multistrato. Frame in solid wood and plywood. Korpus aus Massiv- und schichtverleimtem Holz.
- 2:** Poliuretano a densità differenziata. Differentiated density polyurethane. Polyurethan differenzierter Dichten.
- 3:** Fibra Poliestere. Polyester Fibre. Polyesterfaser.
- 4:** Fodera in tela. Fabric lining. Schonbezug.
- 5:** Poliuretano. Polyurethane. Polyurethan.
- 6:** Nastri elastici intrecciati. Elastic belts interwoven. Geflochtene elastische Gurte.

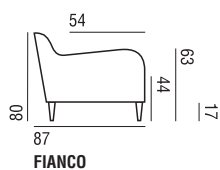

**FIANCO**

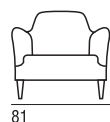

**POLTRONA**



**DIVANO 144**

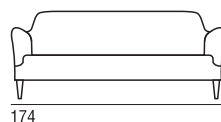

**DIVANO 174**

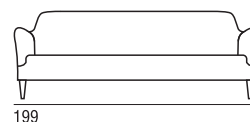

**DIVANO 199**

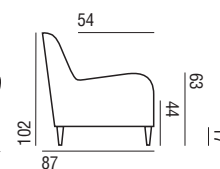

**FIANCO  
POLTRONA ALTA**

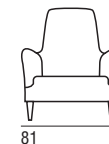

**POLTRONA  
ALTA**

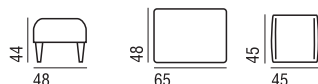

**FIANCO POUF**



**POUF 65**



**CUSCINO 45X45**



**Caratteristiche:** Fold, grazie alla profondità di soli 85 cm, è una collezione pensata per gli spazi contenuti e raffinati che si caratterizza nel suo design e nella sua personalità per una serie di cuciture che traggono ispirazione dal sistema di chiusura della busta. Fold si compone di divani, laterali, chaise longue, dormeuse e terminale da combinare in base alle proprie esigenze. Da sottolineare la doppia funzione che i moduli con bracciolo possono svolgere: quelli con un bracciolo possono essere utilizzati sia come laterale che come angolo; quelli con due braccioli sia come divano che come angolo laterale. Allo stesso modo la dormeuse può essere utilizzata come modulo indipendente o inserita come dormeuse angolo in una composizione. Completano l'offerta la poltrona, le cui dimensioni sono più ridotte rispetto agli altri moduli, i pouf, comodi cuscini e poggiatesta. A seconda del rivestimento scelto la fodera si realizza in due diverse finiture: con cucitura ribattuta semplice o con "Punto Cavallo" (vedi listino prezzi) Il "Punto Cavallo" è un'impuntura decorativa disponibile in 11 colori da abbinare a piacere al tessuto da scegliere fra quelli indicati come idonei (vedi listino prezzi). La finitura "Punto Cavallo" si fornisce con supplemento di prezzo. Il rivestimento è completamente e facilmente sfoderabile (ad eccezione della versione in Pelle) e i componibili vengono forniti di serie con un pratico sistema di aggancio. **Versione Pelle:** La versione con rivestimento in Pelle ha una lavorazione diversa da quella in tessuto. Viene realizzata solamente con la cucitura ribattuta semplice e senza la tasca aperta posta sulla sommità del bracciolo (vedi listino prezzi). **Struttura:** Fusto in legno massello e multistrato, molleggio con nastri elastici intrecciati. Il piede è in fusione disponibile nelle seguenti finiture: cromato, verniciato bianco opaco (RAL 9010), rosso opaco (RAL 3027) oppure grigio opaco (RAL 7022). **Imbottiture:** In poliuretano espanso indeformabile a densità differenziata, la seduta ha lo strato superiore in poliuretano Memory Foam e il tutto è ricoperto da uno strato di fibra poliester, che dona un aspetto morbido e vissuto che va accettato in quanto voluto. Prerivestimento in tela bianca di cotone. I cuscini e i poggiatesta sono in piuma d'oca e anitra bianca vergine.

**Features:** Fold has been thought for limited but refined spaces, thanks to its depth of just 85 cm, where its particular stitching, reminding the sealing of envelopes, characterize the design and personality of this collection. The range includes sofas, side pieces, chaise longue, dormeuse and end piece in order to answer to the different client's needs. To be emphasised is the double use of the modules with armrest: those with one armrest can be used as side- or corner pieces, while those with two arms work as sofas or as side corners. Likewise, dormeuse can be used either as a free-standing module or as a corner dormeuse when combined with other elements. Proportioned armchair, poufs comfortable cushions and lumbar cushions complete the range. According to the chosen fabric upholstery the cover can be delivered in two different finishes: single lapped seam or with Punto Cavallo (see price list). Punto Cavallo is a decorative stitching available in 11 colours to be matched at pleasure to fabric to choose among those specified as suitable for this finish (see price list). There is an up charge for the Punto Cavallo option. Covers are completely and easily removable (except for the leather version). For composition a practical connecting system is also provided. **Cover in leather:** finishing of the covers in leather differs from the one in fabric. Cover in leather is provided with the single lapped seam only, and without the pocket on the upper part of the armrest. **Framework:** Frame is in solid wood and plywood, sprung with interwoven elastic bands. Feet are in cast, available in four finishes: chrome, white-matt (RAL 9010), red-matt (RAL 3027) or grey-matt (RAL 7022) painted. **Padding:** Fold is padded with differentiated density non-deformable polyurethane foam, the upper layer of the seat is in Memory Foam polyurethane finished with polyester fibre, giving a soft and aged appearance that must be accepted as it is intentional. Underlining in white cotton. Cushions and Lumbar Cushions are in goose and duck white, new feathers.

**Eigenschaften:** Dank seiner Tiefe von 85 cm, ist Fold eine Kollektion, die für etwas kleinere und elegante Räumlichkeiten gedacht ist. Ihre Nahtverarbeitung, die sich am Verschlusssystem eines Kuverts inspiriert, charakterisiert ihr Design und ihre Persönlichkeit. Die Kollektion Fold bietet Sofas, Seitenteile, Chaiselongue, Dormeuse und Endelemente, die je nach Bedarf miteinander kombiniert werden können. Hervorzuheben sei die mögliche Doppelfunktion der Elemente mit Armlehne: Elemente mit einer Armlehne können sowohl als Seitenteil als auch als Eckelement eingesetzt werden; die Elemente mit zwei Armlehnen sowohl als Sofa als auch als Seiteneckteil. Ebenso kann die Dormeuse entweder als alleinstehendes Modul oder als Eckdormeuse gestellt werden. Ein Sessel, dessen Maße, im Vergleich zu den anderen Elementen der Kollektion, reduzierter sind, rundet, zusammen mit den Hockern, bequemen Wurf- und Lendenkissen, das Angebot ab. Je nach Stoffwahl kann der Bezug in zwei unterschiedlichen Verarbeitungen realisiert werden: einfache Kappnaht oder Ziernaht „Punto Cavallo“ (siehe Preisliste). Letztere ist in 11 Farben erhältlich und kann nach Wunsch mit den dafür geeigneten Stoffen kombiniert werden (siehe Preisliste). Die Verarbeitung mit Punto Cavallo ist mit einem Aufpreis verbunden. Der Bezug ist leicht und vollständig abnehmbar (Leder-Version ausgenommen) und die Anbauelemente sind serienmäßig mit einem praktischen Verbindungssystem ausgestattet. **Lederbezug:** Die Ausführung in Leder hat eine andere Verarbeitung als die Stoffversion. Sie wird ausschließlich mit einfacher Kappnaht und ohne die spezielle Faltung auf der Oberseite der Armlehne realisiert. **Struktur:** Korpus aus Massiv- und Mehrschichtholz, Federung mit geflochtenen elastischen Gurten. Das gegossene Fußgestell ist in folgenden Ausführungen erhältlich: verchromt, mattlackiert in Weiß (RAL 9010), Rot (RAL 3027) oder Grau (RAL 7022). **Polsterungen:** Formstabiles Polyurethan mit differenzierten Dichten, wobei die obere Schicht des Sitzkissens aus Polyurethan „Memory Foam“ besteht und das Ganze eine Schicht Polyesterfaser überzieht, das ein weiches und „gelebtes“ Aussehen verleiht, das gewollt ist und als solches akzeptiert werden muss. Unterbezug aus weißer Baumwolle. Die Füllung der Wurf- und Lendenkissen ist aus neuen, weißen Gänse- und Entenfedern.

#### PIEDE FOOT FUSS

Fusione di metallo verniciato opaco color bianco (RAL 9010);  
 fusione di metallo verniciato opaco color rosso (RAL 3027);  
 fusione di metallo verniciato opaco color grigio (RAL 7022);  
 fusione di metallo finitura a cromo.  
 Feet in cast finishing white-matt (RAL 9010) painted;  
 feet in cast finishing red-matt (RAL 3027) painted;  
 feet in cast finishing grey-matt (RAL 7022) painted;  
 feet in cast finishing chrome.  
 Fuß in Metallguß mattlackiert Weiß (RAL 9010);  
 Fuß in Metallguß mattlackiert Rot (RAL 3027);  
 Fuß in Metallguß mattlackiert Grau (RAL 7022);  
 Fuß in Metallguß verchromt.

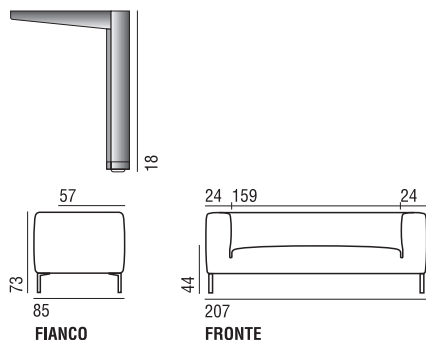

#### SEZIONE SECTION SEKTION

- 1: Pannello multistrato. Plywood base-panel. Mehrschichtholz.
- 2: Fusto in legno massello e multistrato. Frame in solid wood and plywood. Korpus aus Massiv- und Mehrschichtholz.
- 3: Poliuretano a densità differenziata. Differentiated density polyurethane. Polyurethan differenzierter Dichte.
- 4: Fodera in tela. Fabric lining. Schonbezug.
- 5: Fibra Poliester. Polyester Fibre. Polyesterfaser.
- 6: Poliuretano Memory Foam. Polyurethane Memory Foam. Polyurethan Memory Foam.
- 7: Nastri elastici intrecciati. Elastic belts interwoven. Geflochtene elastische Gurte.

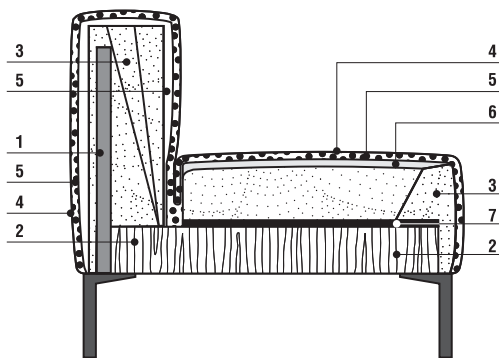

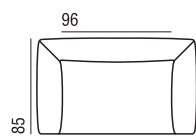

144  
**DIVANO 144**  
LATERALE ANGOLO 144 DX - SX

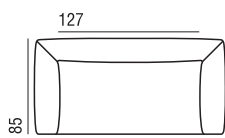

175  
**DIVANO 175**  
LATERALE ANGOLO 175 DX - SX

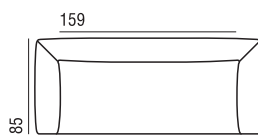

207  
**DIVANO 207**  
LATERALE ANGOLO 207 DX - SX

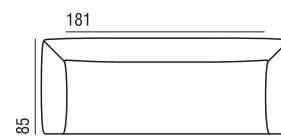

229  
**DIVANO 229**  
LATERALE ANGOLO 229 DX - SX

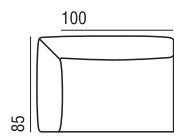

124  
**LATERALE 124 SX**  
ANGOLO 124 SX

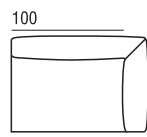

124  
**LATERALE 124 DX**  
ANGOLO 124 DX

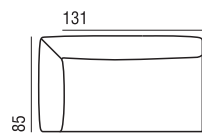

155  
**LATERALE 155 SX**  
ANGOLO 155 SX

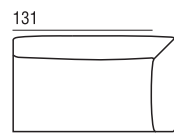

155  
**LATERALE 155 DX**  
ANGOLO 155 DX

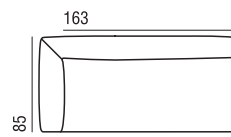

187  
**LATERALE 187 SX**  
ANGOLO 187 SX

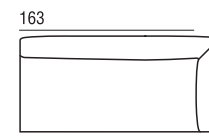

187  
**LATERALE 187 DX**  
ANGOLO 187 DX

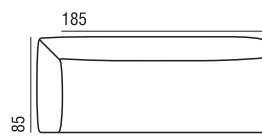

209  
**LATERALE 209 SX**  
ANGOLO 209 SX

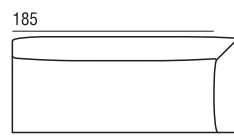

209  
**LATERALE 209 DX**  
ANGOLO 209 DX

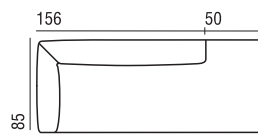

206  
**DORMEUSE 206 SX**

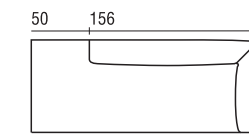

206  
**DORMEUSE 206 DX**

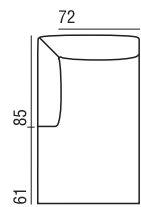

**CHAISE LONGUE SX**

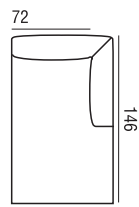

**CHAISE LONGUE DX**

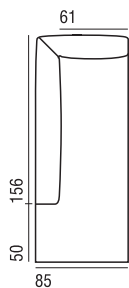

**DORMEUSE ANGOLO SX**

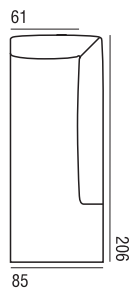

**DORMEUSE ANGOLO DX**

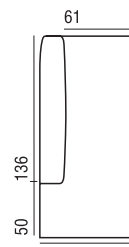

**TERMINALE 186 SX**

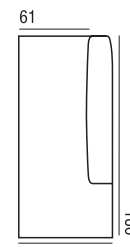

**TERMINALE 186 DX**

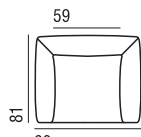

**POLTRONA**

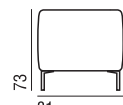

**FIANCO**

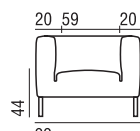

**FRONTE**



**FIANCO POUF**

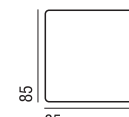

**POUF 85x85**

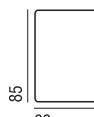

**POUF 62x85**



**CUSCINO 42x42**



**CUSCINO 54x33**

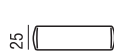

**CUSCINO POGGIARENI 86**

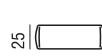

**CUSCINO POGGIARENI 72**



**CUSCINO POGGIARENI 56**



**CUSCINO POGGIARENI 40**

FINITURE - FINISHING - AUSFÜHRUNGEN



Cucitura Punto Cavallo  
Stitching Punto Cavallo  
Ziernaht Punto Cavallo

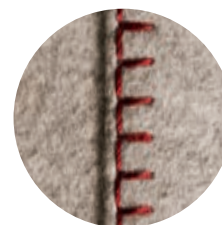

Cucitura ribattuta semplice  
Single lapped seam  
einfache Kappnaht

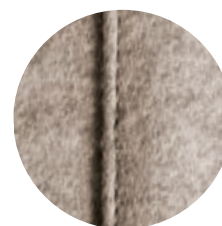

Cucitura versione tessuto Punto Cavallo  
Fabric version stitching Punto Cavallo  
Stoffversion Zierstich Punto Cavallo



Cucitura versione pelle solo ribattuta semplice con tasca chiusa  
Leather version single lapped seam only closed pocket  
Lederversion einfache Kappnaht Nur mit geschlossener Falte



**Caratteristiche:** Linea elegante dalle studiate proporzioni conquista slancio e leggerezza grazie al piede a ponte in alluminio su cui poggia la struttura. La collezione offre un'ampia gamma di divani, elementi, laterali, angoli, chaise-longue, dormeuse e pouf per un totale di 96 moduli diversi, che abbinati a piacere, offrono la possibilità di creare innumerevoli combinazioni. Una poltrona di dimensioni contenute completa la gamma. Hampton offre la possibilità di scegliere fra due differenti versioni di schienale: con schienali rettangolari (tipo "A") o con cuscini-schienale (tipo "B" cm. 57x57) in quantità predefinita. Per permettere una maggiore personalizzazione Hampton si può scegliere anche nella versione "BASE" (senza cuscini-schienale) da completare con i cuscini-schienale scelti fra le diverse misure in collezione. Comodi poggiatesta, cuscini-schienale e cuscini in diverse misure sono disponibili come optional. I cuscini di seduta sono disponibili, a seconda dei moduli, sia con il cuscino unico sia con i cuscini divisi. Per i divani (con due braccioli) e la poltrona, la fodera della struttura, di serie tesa, si può realizzare anche con gonna. Con gonna i piedi sono cilindrici. Il rivestimento è completamente e facilmente sfoderabile. Hampton è attrezzabile con i tavolini: Argo e Jim. **Struttura:** Fusto in legno massello e multistrato, imbottito in poliuretano espanso indeformabile a densità differenziata, molleggio con nastri elastici intrecciati. Prerivestimento con tela di cotone accoppiata con fibra poliestere. Il piede, nella versione tesa, è a ponte: di serie in fusione di alluminio brunito e, su richiesta, in fusione di alluminio lucidato. Nella versione con gonna (divani e poltrona) i piedi sono cilindrici. In entrambe le versioni è disponibile, solo su richiesta, il piede più alto di cm. 3 rispetto allo standard. **Imbottitura:** Cuscini-schienale tipo "A" in piuma canalizzata con inserto in poliuretano; cuscini-schienale tipo "B" interamente in piuma canalizzata. Di serie i cuscini di seduta sono in piuma canalizzata con inserto in poliuretano a densità differenziata. Il cuscino di seduta in piuma e poliuretano offre un comfort speciale, proprio della piuma, che dona alle imbottiture un aspetto piacevolmente vissuto che va accettato in quanto inevitabile. Su richiesta si forniscono i cuscini di seduta in poliuretano a densità differenziata e fibra poliestere. In entrambi i casi i cuscini di seduta sono disponibili, a seconda dei moduli, sia con il cuscino unico sia con i cuscini divisi. Tutte le imbottiture sono interamente prerivestite con tela bianca.

**Features:** Elegant line and studied proportions, which obtain burst and determination through its bridge-shaped foot supporting the framework. This collection offers a wide range of sofas, elements, side pieces, corners, chaise-longue, dormeuse, and poufs for a total number of 96 different modules, which can be freely combined and give the possibility to create countless combinations. A small armchair completes the range. Hampton offers the possibility to choose between two different backrest versions: with rectangular backrests (type "A") or with backrest-cushions (type "B" 57x57 cm) in a predefined quantity. To allow more customization possibilities, Hampton is also available in the "BASE" version (without backrests cushions) to be completed with backrest-cushions selected among the various sizes in the collection. Comfortable lumbar cushions, backrest-cushions, and cushions in various sizes are available as optional. The seat cushions are available, according to the modules, either unique or divided. For the sofas (with two arms) and armchair, the framework cover, of the tensed series, can also be made with skirting. With skirting, the feet are cylindrical. The cover can be completely and easily removed. Hampton can be equipped with tables: Argo and Jim. **Structure:** Frame made of solid and plywood, padded with non-deformable expanded polyurethane of differentiated density, and sprung with interwoven elastic belts. Cotton lining coupled with polyester fibre. In the version without skirt, the foot is bridge-shaped: burnished cast aluminium series and polished cast aluminium, upon request. In the version with skirting (sofas and armchair) the foot is cylindrical. Upon request both versions are available with feet 3 cm higher than standard. **Cushion padding:** Backrest-cushions type "A" with canalised feather and polyurethane insert; Backrest-cushions type "B" entirely made with canalised feather. The standard seat cushions are made with canalised feather and polyurethane insert with differentiated density. The seat cushion with feather and polyurethane provides the typical special comfort of feather, as well as a pleasantly used aspect of padding, which has to be accepted as it cannot be avoided. Differentiated density polyurethane and polyester fibre seat cushions are available upon request. In both versions, and according to the modules, the seat cushions can be either unique or divided. All padding is fully lined with white fabric.

**Eigenschaften:** Schmale, brückenförmige Aluminiumfüße, die die gesamte Struktur stützen, betonen die elegante und harmonische Form des Modells. Hampton bietet eine große Bandbreite an Modulen: Sofas, Seitenteile, Eckstücke, Chaiselongue, Dormeuse und Hocker - insgesamt 96 verschiedene, individuell kombinierbare Elemente. Ein kleiner Sessel vervollständigt die Kollektion. Zwei Rückenlehnen stehen zur Auswahl: die traditionelle mit geraden, rechteckigen Rückenkissen (Typ A) oder die Variante mit quadratischen Wurfkissen (57 x 57 cm Typ B), mit einer, je nach Element, vorgegebenen Standardanzahl. Mehr Individualität bei der Zusammenstellung des Sofasystems ermöglicht die Version "BASIS" ohne Standard-Rückenkissen. Diese werden durch Wurfkissen unterschiedlicher Maße ersetzt. Die Option bequemer Lendenstützen, Rückenkissen und verschiedener Kissenvarianten erleichtern die Erfüllung individueller Ansprüche an Komfort und Ästhetik. Die Sitzkissen sind, je nach Element, als durchgehendes oder als geteilte Einzelkissen erhältlich. Die Sofas (mit zwei Armlehnen) und der Sessel können entweder mit einem Bezug ohne oder mit Volant realisiert werden. Bei Bezügen mit Volant sind die Füße zylindrisch. Die Bezüge sind leicht und vollständig abziehbar. Die Beistellische Argo und Jim ergänzen das Angebot. **Struktur:** Der Rahmen besteht aus Massiv- und Mehrschichtholz, gepolstert mit formstabilem Polyurethan unterschiedlicher Dichten und einer Federung mit geflochtenen elastischen Gurten. Das Polster schützt ein Schonbezug aus weißem Baumwollstoff mit Polyesterfaser. Bei Bezügen ohne Volant sind die Füße schmal und brückenartig geformt; serienmäßig in Aluminiumguss brüniert und, auf Anfrage, poliert. Bei Bezügen mit Volant sind die Füße zylindrisch und vom Bezug verdeckt. Auf Anfrage sind beide Varianten mit einem um 3 cm höheren Fuß, verglichen mit der Standardausführung, erhältlich. **Polster:** Rückenkissenfüllung Typ-A mit Federn und einem zusätzlichen Polyurethankingern; Typ-B ausschließlich aus Federn; in beiden Fällen in Kammern gesteppt. Die Standard-Sitzkissen haben eine Federfüllung mit einem Polyurethankingern unterschiedlicher Dichte. Die Sitzkissenvariante mit Federn und Polyurethan bietet besonderen Sitzkomfort, bringt jedoch die für diese Art von Füllung typischen Sitzkuhlen mit sich. Auf Anfrage werden die Sitzkissen auch in differenziertem Polyurethan und Polyesterfasern geliefert. Beide Varianten sind, je nach Element, sowohl als durchgehende als auch als geteilte Sitzkissen, lieferbar. Alle Polster haben einen weißen Schonbezug.

#### PIEDE FOOT FUß

Fusione di alluminio brunito (di serie);  
fusione di alluminio lucidato (su richiesta).  
Burnished cast aluminium (series);  
polished cast aluminium (upon request).  
Standardausführung in Aluminiumguss brüniert;  
Auf Anfrage in Aluminiumguss poliert.

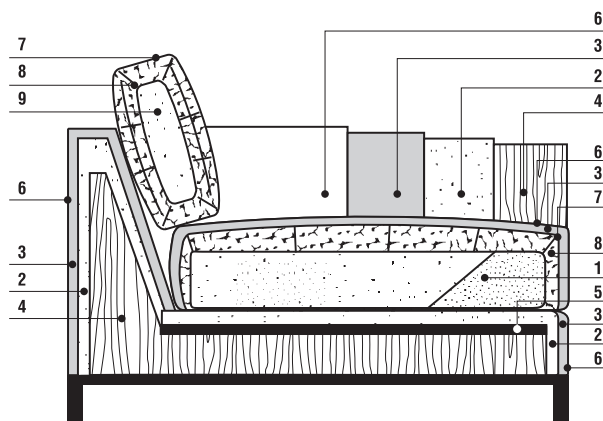

#### SEZIONE SECTION SEKTION

- 1: Poliuretano a densità differenziata.  
Differentiated density polyurethane.  
Polyurethan unterschiedlicher Dichte.
- 2: Poliuretano. Polyurethane. Polyurethan.
- 3: Fibra Poliestere. Polyester Fibre.  
Polyesterfaser.
- 4: Fusto in legno massello e multistrato.  
Frame in solid wood and plywood.  
Rahmen aus Massivholz, oder schichtverleimt.
- 5: Nastri elastici. Elastic belts. Elastische Gurte.
- 6: Fodera in tela. Fabric lining. Schonbezug.
- 7: Fodera in tessuto antipiuma.  
Featherproof fabric cover.  
Federnundurchlässiger Bezug des Kisseninlets.
- 8: Piuma. Down. Federfüllung.
- 9: Inserto in Poliuretano. Polyurethane insert.  
Kern aus Polyurethan.

#### HAMPTON VERSIONE A

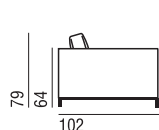

FIANCO

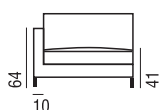

FRONTE  
SEZ. DEL BRACCIOLO

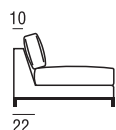

SEZ. DEL FIANCO

#### HAMPTON VERSIONE B

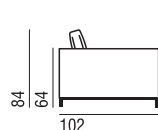

FIANCO

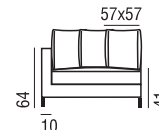

FRONTE

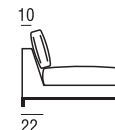

SEZ. DEL FIANCO

HAMPTON VERSIONE A

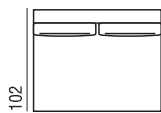

136

**ELEMENTO 136 A**

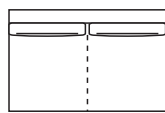

167

**ELEMENTO 167 A**  
cuscino unico/cuscini divisi

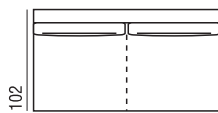

198

**ELEMENTO 198 A**  
cuscino unico/cuscini divisi

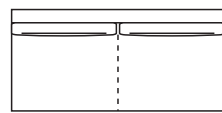

226

**ELEMENTO 226 A**  
cuscino unico/cuscini divisi

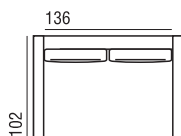

156

**DIVANO 156 A**

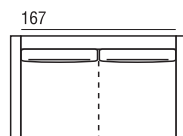

187

**DIVANO 187 A**  
cuscino unico/cuscini divisi

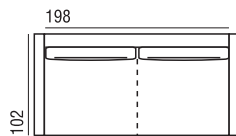

218

**DIVANO 218 A**  
cuscino unico/cuscini divisi

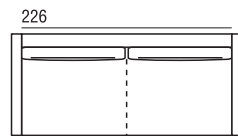

246

**DIVANO 246 A**  
cuscino unico/cuscini divisi

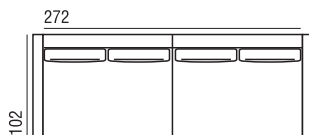

292

**DIVANO 292 A**  
composto da 2 laterali 146 SX e DX

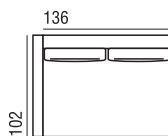

146

**LATERALE 146 SX A**

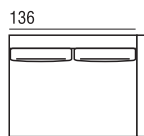

146

**LATERALE 146 DX A**

HAMPTON VERSIONE B

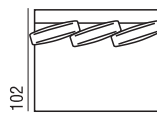

136

**ELEMENTO 136 B**

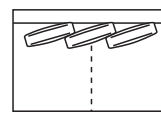

167

**ELEMENTO 167 B**  
cuscino unico/cuscini divisi

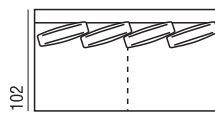

198

**ELEMENTO 198 B**  
cuscino unico/cuscini divisi

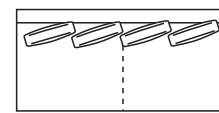

226

**ELEMENTO 226 B**  
cuscino unico/cuscini divisi

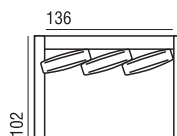

156

**DIVANO 156 B**

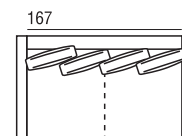

187

**DIVANO 187 B**  
cuscino unico/cuscini divisi

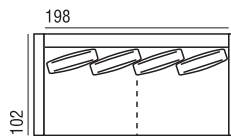

218

**DIVANO 218 B**  
cuscino unico/cuscini divisi

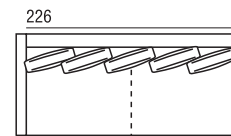

246

**DIVANO 246 B**  
cuscino unico/cuscini divisi

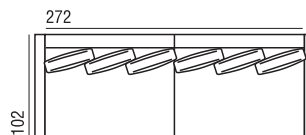

292

**DIVANO 292 B**  
composto da 2 laterali 146 SX e DX

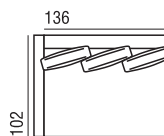

146

**LATERALE 146 SX B**

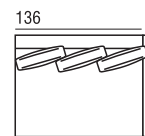

146

**LATERALE 146 DX B**

HAMPTON VERSIONE A

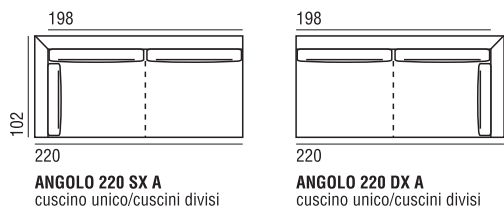
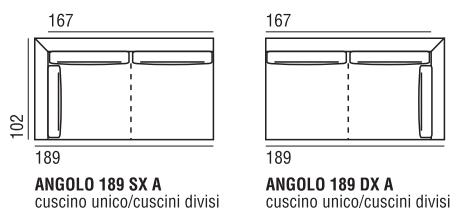
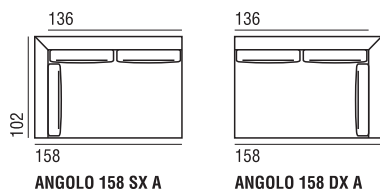
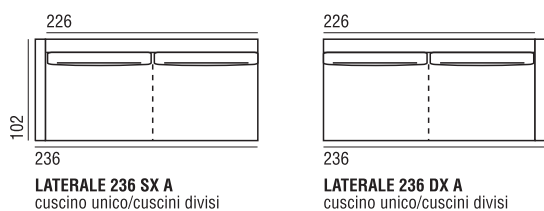
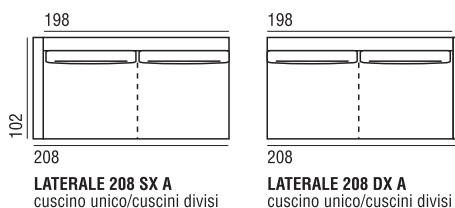
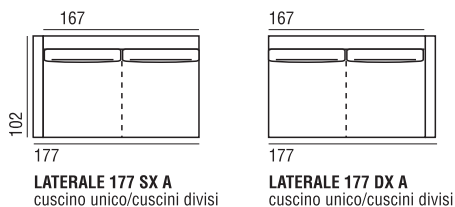

HAMPTON VERSIONE B

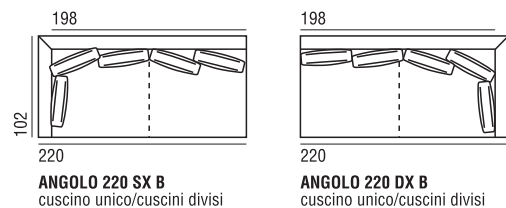
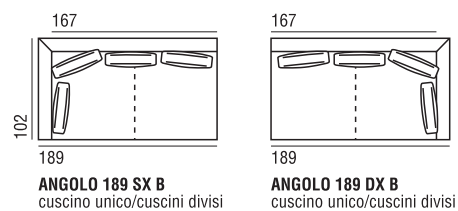
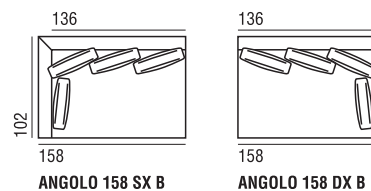
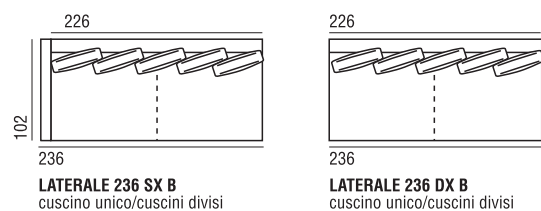
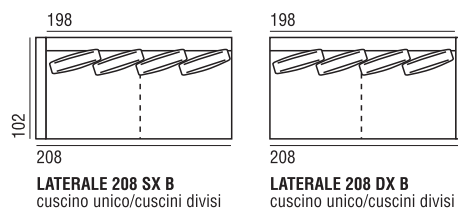
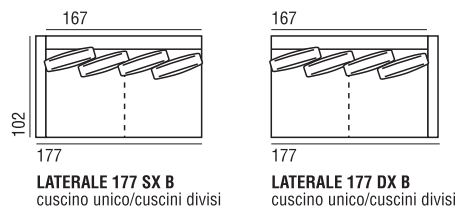



HAMPTON VERSIONE A

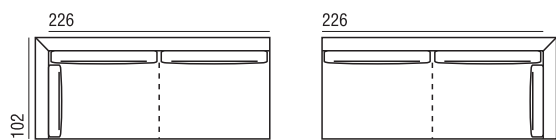

**ANGOLO 248 SX A**  
cuscino unico/cuscini divisi

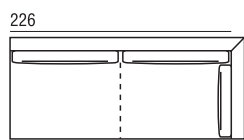

**ANGOLO 248 DX A**  
cuscino unico/cuscini divisi

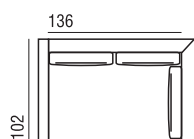

**ANGOLO LATERALE 168 SX A**

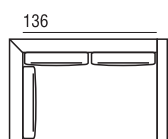

**ANGOLO LATERALE 168 DX A**

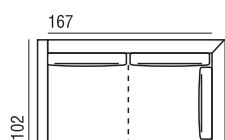

**ANGOLO LATERALE 199 SX A**  
cuscino unico/cuscini divisi

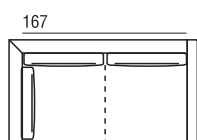

**ANGOLO LATERALE 199 DX A**  
cuscino unico/cuscini divisi

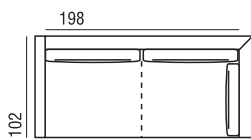

**ANGOLO LATERALE 230 SX A**  
cuscino unico/cuscini divisi

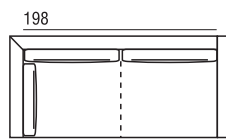

**ANGOLO LATERALE 230 DX A**  
cuscino unico/cuscini divisi

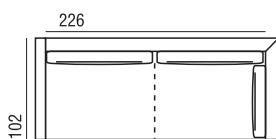

**ANGOLO LATERALE 258 SX A**  
cuscino unico/cuscini divisi

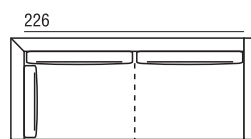

**ANGOLO LATERALE 258 DX A**  
cuscino unico/cuscini divisi

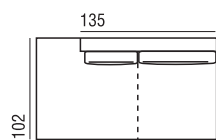

**TERMINALE 180 SX A**  
cuscino unico/cuscini divisi

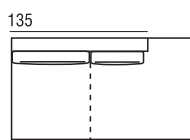

**TERMINALE 180 DX A**  
cuscino unico/cuscini divisi

HAMPTON VERSIONE B

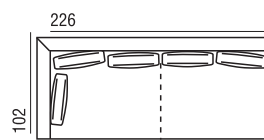

**ANGOLO 248 SX B**  
cuscino unico/cuscini divisi

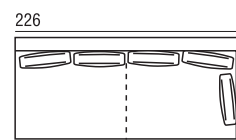

**ANGOLO 248 DX B**  
cuscino unico/cuscini divisi

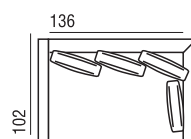

**ANGOLO LATERALE 168 SX B**

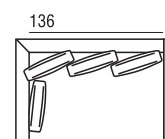

**ANGOLO LATERALE 168 DX B**

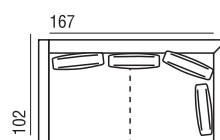

**ANGOLO LATERALE 199 SX B**  
cuscino unico/cuscini divisi

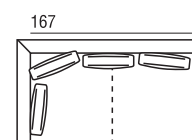

**ANGOLO LATERALE 199 DX B**  
cuscino unico/cuscini divisi

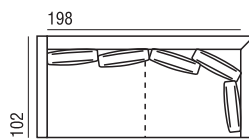

**ANGOLO LATERALE 230 SX B**  
cuscino unico/cuscini divisi

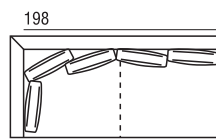

**ANGOLO LATERALE 230 DX B**  
cuscino unico/cuscini divisi

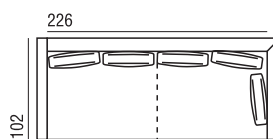

**ANGOLO LATERALE 258 SX B**  
cuscino unico/cuscini divisi

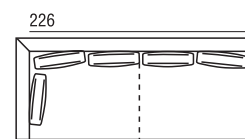

**ANGOLO LATERALE 258 DX B**  
cuscino unico/cuscini divisi

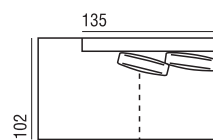

**TERMINALE 180 SX B**  
cuscino unico/cuscini divisi

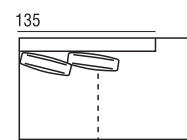

**TERMINALE 180 DX B**  
cuscino unico/cuscini divisi

HAMPTON VERSIONE A

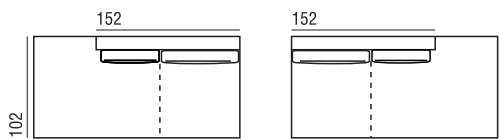

218  
**TERMINALE 218 SX A**  
cuscino unico/cuscini divisi

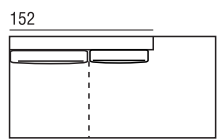

218  
**TERMINALE 218 DX A**  
cuscino unico/cuscini divisi

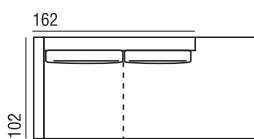

228  
**DORMEUSE 228 SX A**  
cuscino unico/cuscini divisi

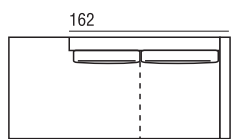

228  
**DORMEUSE 228 DX A**  
cuscino unico/cuscini divisi

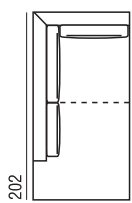

102  
**DORMEUSE ANGOLO 202 SX A**  
cuscino unico/cuscini divisi

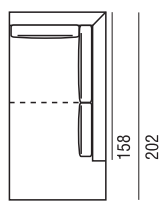

102  
**DORMEUSE ANGOLO 202 DX A**  
cuscino unico/cuscini divisi

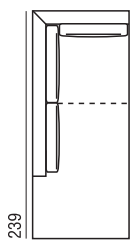

102  
**DORMEUSE ANGOLO 239 SX A**  
cuscino unico/cuscini divisi

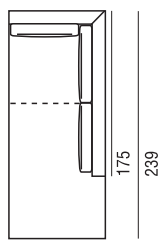

102  
**DORMEUSE ANGOLO 239 DX A**  
cuscino unico/cuscini divisi

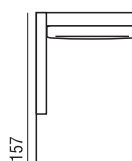

110  
**CHAISE LONGUE 110 SX A**

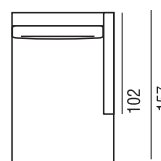

110  
**CHAISE LONGUE 110 DX A**

HAMPTON VERSIONE B

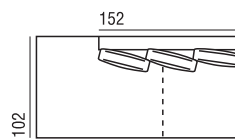

218  
**TERMINALE 218 SX B**  
cuscino unico/cuscini divisi

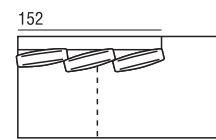

218  
**TERMINALE 218 DX B**  
cuscino unico/cuscini divisi

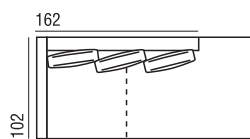

228  
**DORMEUSE 228 SX B**  
cuscino unico/cuscini divisi

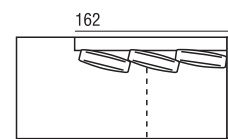

228  
**DORMEUSE 228 DX B**  
cuscino unico/cuscini divisi

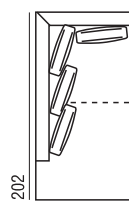

102  
**DORMEUSE ANGOLO 202 SX B**  
cuscino unico/cuscini divisi

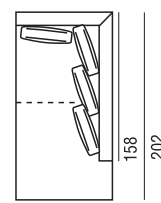

102  
**DORMEUSE ANGOLO 202 DX B**  
cuscino unico/cuscini divisi

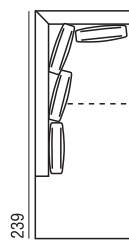

102  
**DORMEUSE ANGOLO 239 SX B**  
cuscino unico/cuscini divisi

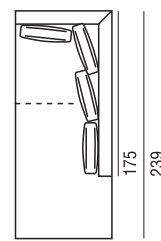

102  
**DORMEUSE ANGOLO 239 DX B**  
cuscino unico/cuscini divisi

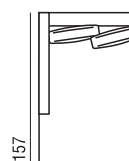

110  
**CHAISE LONGUE 110 SX B**

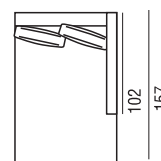

110  
**CHAISE LONGUE 110 DX B**

**HAMPTON VERSIONE A**

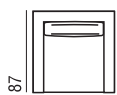

**POLTRONA 87 A**

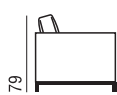

**FIANCO**



**FRONTE**

**HAMPTON VERSIONE B**

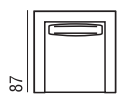

**POLTRONA 87 B**



**FIANCO**

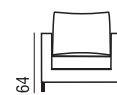

**FRONTE**



**FIANCO POUF**



**POUF 102x102**



**POUF 70x102**



**POUF 120x80**



**SCHIENALE 65x65**



**SCHIENALE 57x57 (tipo B)**



**SCHIENALE 48x48**



**CUSCINO 45x45**



**CUSCINO 41x41**



**CUSCINO 54x33**



**CUSCINO POGGIARENI 86**



**CUSCINO POGGIARENI 72**



**CUSCINO POGGIARENI 56**



**CUSCINO POGGIARENI 40**



**Caratteristiche:** Linea elegante dalle studiate proporzioni conquista slancio e leggerezza grazie al piede in alluminio a ponte su cui poggia la struttura. Il cuscino di seduta a martello rivisita in chiave moderna il classico divano senza tempo. La collezione offre una gamma di divani di diverse misure e pouf. Una poltrona della stessa linea ma di misura più contenuta completa il programma. Hampton Memory offre la possibilità di scegliere fra due differenti versioni di schienale: con schienali rettangolari (tipo "A") o con cuscini-schienale (tipo "B" cm. 57x57) in quantità predefinita. Per permettere una maggiore personalizzazione Hampton Memory si può scegliere anche nella versione "BASE" (senza cuscini-schienale) da completare con i cuscini-schienale scelti fra le diverse misure in collezione. Comodi poggiatesta, cuscini-schienale e cuscini in diverse misure sono disponibili come optional. La fodera della struttura, di serie tesa, si può realizzare anche con gonna e in questo caso i piedi sono cilindrici. Il rivestimento è completamente e facilmente sfoderabile. Hampton Memory è attrezzabile con i tavolini: Argo e Jim. **Struttura:** Fusto in legno massello e multistrato, imbottito in poliuretano espanso indeformabile a densità differenziata, molleggio con nastri elastici intrecciati. Prerivestimento con tela di cotone accoppiata con fibra poliestere. Il piede, nella versione tesa, è a ponte: di serie in fusione di alluminio brunito e, su richiesta, in fusione di alluminio lucidato. Nella versione con gonna i piedi sono cilindrici. In entrambe le versioni è disponibile, solo su richiesta, il piede più alto di cm. 3 rispetto allo standard. **Imbottitura:** Cuscini-schienali tipo "A" in piuma canalizzata con inserto in poliuretano; cuscini-schienale tipo "B" interamente in piuma canalizzata. Di serie i cuscini di seduta sono in piuma canalizzata con inserto in poliuretano a densità differenziata. Il cuscino di seduta in piuma e poliuretano offre un comfort speciale, proprio della piuma, che dona alle imbottiture un aspetto piacevolmente vissuto che va accettato in quanto inevitabile. Su richiesta si forniscono i cuscini di seduta in poliuretano a densità differenziata e fibra poliestere. In entrambi i casi, i cuscini di seduta, a seconda dei moduli, sono solo con il cuscino unico o con i cuscini divisi. Tutte le imbottiture sono interamente prerivestite con tela bianca.

**Features:** Elegant line and studied proportions, which obtain burst and determination through its bridge-shaped foot supporting the framework. The hammer seat cushion is a modern development of timeless classical sofas. This collection offers a wide range of sofas of various sizes and poufs. A small armchair with the same design completes the range. Hampton Memory offers the possibility to choose between two different backrest versions: with rectangular backrests (type "A") or with backrest-cushions (type "B" 57x57 cm) in a predefined quantity. To allow more customization possibilities, Hampton Memory is also available in the "BASE" version (without backrests cushions) to be completed with backrest-cushions selected among the various sizes in the collection. Comfortable lumbar cushions, backrest-cushions, and cushions in various sizes are available as optional. The framework cover, of the tensed series, can also be made with skirting. With skirting, the feet are cylindrical. The cover can be completely and easily removed. Hampton Memory can be equipped with tables: Argo and Jim. **Structure:** Frame made of solid and plywood, padded with non-deformable expanded polyurethane of differentiated density, and sprung with interwoven elastic belts. Cotton lining coupled with polyester fibre. In the version without skirt, the foot is bridge-shaped: burnished cast aluminium series and polished cast aluminium, upon request. In the version with skirting, the foot is cylindrical. Upon request both versions are available with feet 3 cm higher than standard. **Cushion padding:** Backrest-cushions type "A" with canalised feather and polyurethane insert; Backrest-cushions type "B" entirely made with canalised feather. The standard seat cushions are made with canalised feather and polyurethane insert with differentiated density. The seat cushion with feather and polyurethane provides the typical special comfort of feather, as well as a pleasantly used aspect of padding, which has to be accepted as it cannot be avoided. Differentiated density polyurethane and polyester fibre seat cushions are available upon request. In both versions, and according to the modules, the seat cushions are delivered only unique or divided. All padding is fully lined with white fabric.

**Eigenschaften:** Schmale, brückenförmige Aluminiumfüße, die die gesamte Struktur stützen, betonen die elegante und harmonische Form des Modells. Die L-förmigen Sitzkissen sind eine moderne Weiterentwicklung des klassischen Sofas. Die Kollektion bietet eine große Bandbreite an Sofas in unterschiedlichen Größen sowie mehrere Hocker. Ein Sessel der gleichen Linie, jedoch mit reduzierten Maßen, ergänzt das Programm. Zwei Rückenlehnen stehen zur Auswahl: die traditionelle mit geraden, rechteckigen Rückenkissen (Typ A) oder die Variante mit quadratischen Wurfkissen (57 x 57 cm Typ B), mit einer, je nach Element, vorgegebenen Standardanzahl. Mehr Individualität bei der Zusammenstellung des Sofasystems ermöglicht die Version "BASIS" ohne Standard-Rückenkissen. Diese werden durch Wurfkissen unterschiedlicher Maße ersetzt. Die Option bequemer Lendenstützen, Rückenkissen und verschiedener Kissenvarianten erleichtern die Erfüllung individueller Ansprüche an Komfort und Ästhetik. Serienmäßig ist der Bezug ohne Volant, kann jedoch auch mit realisiert werden, wobei in letzterem Fall zylindrische Füße montiert werden. Alle Bezüge sind leicht und vollständig abziehbar. Die Beistelltische Argo und Jim ergänzen das Programm. **Struktur:** Der Rahmen besteht aus Massiv- und Mehrschichtholz, gepolstert mit formstabilem Polyurethan unterschiedlicher Dichte und einer Federung mit geflochtenen elastischen Gurten. Das Polster schützt ein Schonbezug aus weißem Baumwollstoff mit Polyesterfaser. Bei Bezügen ohne Volant sind die Füße schmal und brückenartig geformt; serienmäßig in Aluminiumguss, brüniert und, auf Anfrage, poliert. Bei Bezügen mit Volant sind die Füße zylindrisch und vom Bezug verdeckt. Auf Anfrage sind beide Varianten mit einem um 3 cm höheren Fuß, verglichen mit der Standardausführung, erhältlich. **Polster:** Während die Rückenkissen Typ-A mit Federn und einem zusätzlichen Polyurethankern gefüllt sind, besteht das Innenleben der Rückenkissen Typ-B ausschließlich aus Federn; in beiden Fällen in Kammern gesteppt. Die Standard-Sitzkissen haben eine Federfüllung mit einem Polyurethankern unterschiedlicher Dichte. Die Sitzkissen-Variante mit Federfüllung und Polyurethan bietet besonders weichen Sitzkomfort, bringt jedoch die für diese Art von Füllung typischen Sitzkuhlen mit sich. Auf Anfrage werden die Sitzkissen auch in differenziertem Polyurethan und Polyesterfasern geliefert. Beide Varianten sind, je nach Element, entweder nur mit durchgehendem oder nur mit getrennten Sitzkissen lieferbar. Alle Polster haben einen weißen Schonbezug.

## PIEDE FOOT FUß

Fusione di alluminio brunito (di serie);  
fusione di alluminio lucidato (su richiesta).  
Burnished cast aluminium (series);  
polished cast aluminium (upon request).  
Standardausführung in Aluminiumguss brüniert;  
Auf Anfrage in Aluminiumguss poliert.

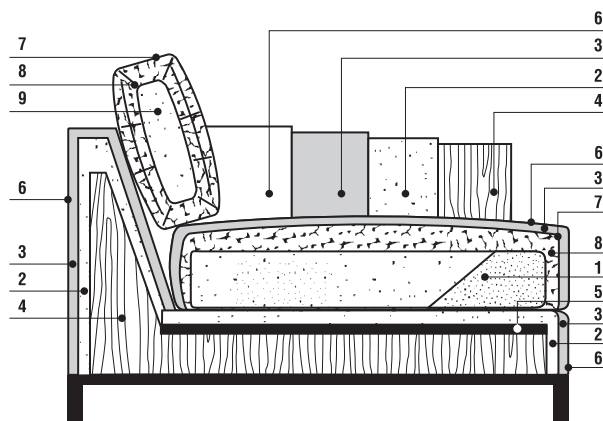

## SEZIONE SECTION SEKTION

- 1: Poliuretano a densità differenziata.  
Differentiated density polyurethane.  
Polyurethane unterschiedlicher Dichte.
- 2: Poliuretano. Polyurethane. Polyurethan.
- 3: Fibra Poliestere. Polyester Fibre.  
Polyesterfaser.
- 4: Fusto in legno massello e multistrato.  
Frame in solid wood and plywood.  
Rahmen aus Massivholz, oder schichtverleimt.
- 5: Nastri elastici. Elastic belts. Elastische Gurte.
- 6: Fodera in tela. Fabric lining. Schonbezug.
- 7: Fodera in tessuto antipiuma.  
Featherproof fabric cover.  
Federnundurchlässiger Bezug des Kisseninlets.
- 8: Piuma. Down. Federfüllung.
- 9: Inserto in Poliuretano. Polyurethane insert.  
Kern aus Polyurethan.

## HAMPTON MEMORY VERSIONE A

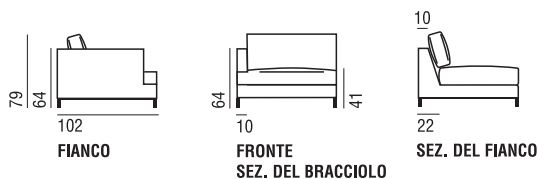

## HAMPTON MEMORY VERSIONE B

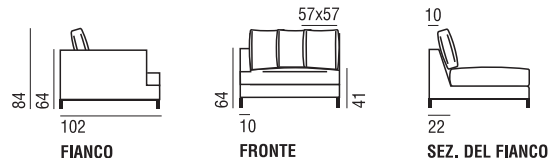

HAMPTON MEMORY VERSIONE A

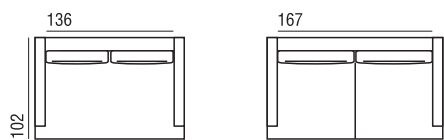

136  
102  
156  
**DIVANO 156 A**

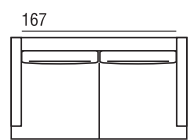

167  
102  
187  
**DIVANO 187 A**

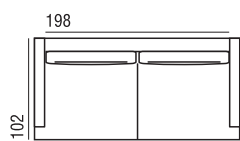

198  
102  
218  
**DIVANO 218 A**

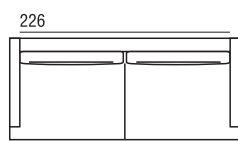

226  
102  
246  
**DIVANO 246 A**

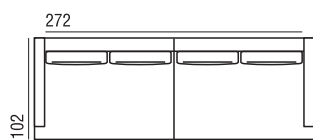

272  
102  
292  
**DIVANO 292 A**  
composto da 2 laterali 146 SX e DX

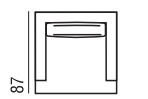

87  
87  
**POLTRONA 87 A**

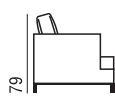

79  
87  
**FIANCO**



64  
87  
**FRONTE**



41  
**FIANCO POUF**



102  
102  
**POUF 102x102**



70  
102  
**POUF 70x102**



80  
120  
**POUF 120x80**



65  
65  
**SCHIENALE 65x65**



57  
57  
**SCHIENALE 57x57 (tipo B)**



48  
48  
**SCHIENALE 48x48**

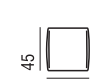

45  
45  
**CUSCINO 45x45**



41  
41  
**CUSCINO 41x41**



33  
54  
**CUSCINO 54x33**

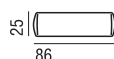

25  
86  
**CUSCINO POGGIARENI 86**

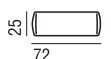

25  
72  
**CUSCINO POGGIARENI 72**



25  
56  
**CUSCINO POGGIARENI 56**

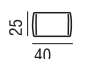

25  
40  
**CUSCINO POGGIARENI 40**

HAMPTON MEMORY VERSIONE B

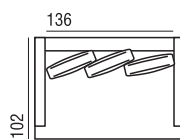

136  
102  
156  
**DIVANO 156 B**

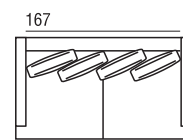

167  
102  
187  
**DIVANO 187 B**

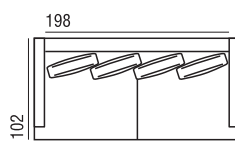

198  
102  
218  
**DIVANO 218 B**

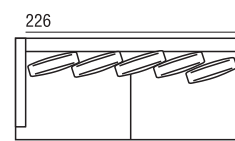

226  
102  
246  
**DIVANO 246 B**

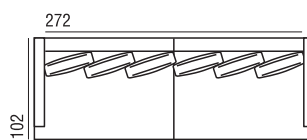

272  
102  
292  
**DIVANO 292 B**  
composto da 2 laterali 146 SX e DX

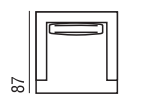

87  
87  
**POLTRONA 87 B**

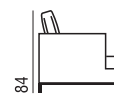

84  
87  
**FIANCO**

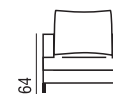

64  
87  
**FRONTE**



**Caratteristiche:** Divano informale di design essenziale ed elegante, può essere utilizzato come divano normale o come ampia dormeuse, ideale per un uso a centro stanza in quanto utilizzabile da entrambi i lati. È disponibile un morbido schienale in piuma per assecondare al meglio le personali esigenze di comfort. La collezione è completata da un elemento senza braccioli e da un comodo pouff. È completamente sfoderabile. Itaca è anche attrezzabile con il tavolino Argo. **Struttura:** Fusto in legno massello e multistrato, molleggio con nastri elastici intrecciati. Piedi in faggio laccato colore nero. **Imbottitura:** In poliuretano espanso indeformabile a densità differenziata più fibra poliestere; prerinvestimento in tela di cotone accoppiata con fibra poliestere. Cuscini-schienali in piuma lavata e sterilizzata.

**Features:** Informal settee with a simple, elegant design, it can be used as a regular settee or as a comfortable sleeper, ideal to be placed in the middle of the room, as it can be used on both sides. A soft feather-filled backrest is also available to satisfy personal comfort requirements. The collection is completed by an element without armrests and a comfortable pouf. The covers are completely removable. Itaca can be equipped with the small table Argo. **Structure:** Frame in solid wood and plywood, sprung with interwoven elastic bands. Feet in black-stained beech. **Cushion padding:** Non-deformable differentiated density foamed polyurethane and polyester fibre; under-covering in cotton canvas coupled with polyester fibre. Back cushions are filled with washed and sterilised feather.

**Eigenschaften:** Legere Couch mit minimalistischem und elegantem Design, kann als normales Sofa oder als großzügige Dormeuse genutzt werden, ideal für die Stellung in der Mitte eines Zimmers, da sie von beiden Seiten benutzt werden kann. Das Rückenkissen besteht aus weichen Daunen, die den persönlichen Komfort verbessern. Die Kollektion wird durch ein Element ohne Armlehnen und einen bequemen Hocker ergänzt. Der Bezug ist komplett abziehbar. Itaca kann ebenfalls mit dem kleinen Tisch Argo ergänzt werden. **Struktur:** Gerüst aus massiver Buche und Mehrschichtholz, Federung durch geflochtene Elastikgurte. Beine aus schwarz lackierter Buche. **Polsterung:** Aus undeformierbarem Polyurethan unterschiedlicher Dichte und Polyesterfaser, Schonbezug aus Baumwollstoff mit Polyesterfaser. Polsterung der Rückenkissen aus gewaschenen und sterilisierten Daunen.

#### PIEDE FOOT FUB

Massello di faggio laccato color nero.  
Solid beech wood stained black.  
Schwarz lackierte massive Buche.



35

#### SEZIONE SECTION SEKTION

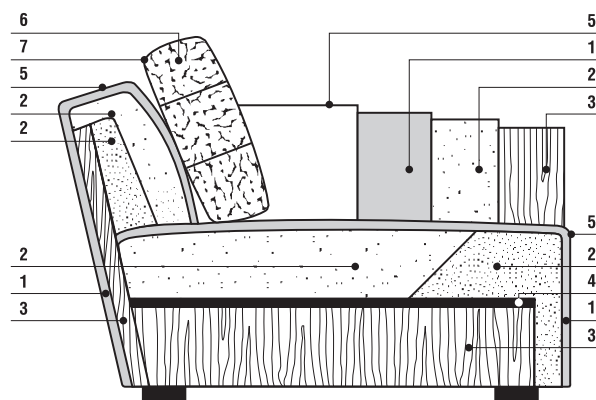

- 1: Fibra Poliestere. Polyester Fibre.  
Polyesterfaser.
- 2: Poliuretano a densità differenziata.  
Differentiated density polyurethane.  
Polyurethan unterschiedlicher Dichte.
- 3: Fusto in legno massello e multistrato.  
Frame in solid wood and plywood.  
Korpus aus Massivholz, schichtverleimt.
- 4: Nastri elastici. Elastic belts. Elastische Gurte.
- 5: Fodera in tela. Fabric lining. Schonbezug.
- 6: Piuma. Down. Federfüllung.
- 7: Fodera in tessuto antipiuma.  
Featherproof fabric cover.  
Federnundurchlässiger Bezug des Kisseninlets.

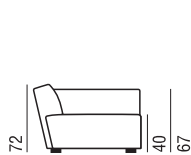

FIANCO

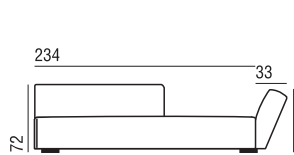

FRONTE

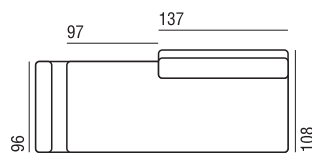

DIVANO 267 SX

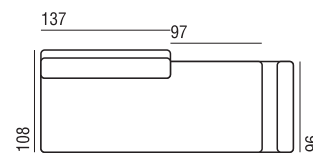

DIVANO 267 DX

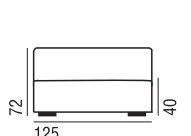

ELEMENTO 125

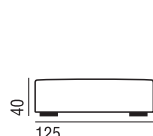
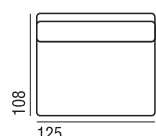

POUF 125

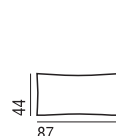
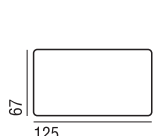

CUSCINO  
SCHIENALE



**Caratteristiche:** La collezione Noe è un sistema che comprende divani così come numerosi elementi componibili, angoli, laterali, chaise longue e vari pouf, i quali, abbinati a piacere, offrono innumerevoli combinazioni. Si richiama alla serie Zoe presentata per la prima volta nel 2006 e diventata in pochi anni una icona del design. La struttura di Noe è realizzata in poliuretano autoportante: ciò consente una seduta tradizionale molto confortevole, senza perdere in brio e in leggerezza. A seconda del rivestimento scelto la fodera si realizza in tre diverse finiture: Al Vivo, Con Bordino o con impuntura "Punto Cavallo". La finitura "Punto Cavallo" si fornisce con supplemento di prezzo. Considerata la forma e le caratteristiche di Noe si sconsiglia l'utilizzo di tessuti troppo leggeri. È disponibile un bracciolo appesantito da sistemare sulla seduta per ottenere un comodo e stabile appoggio. La collezione Noe è completamente e facilmente sfoderabile. Gli elementi vengono forniti di serie di un pratico sistema di aggancio. **Finiture disponibili:** - "Al Vivo": Si esegue esclusivamente con tessuti idonei (vedi listino prezzi) così come con tutti i tipi di pelle. In pelle, di serie, si realizza solo Al Vivo. - "Con Bordino": Con tutti gli altri tessuti la cucitura è di tipo tradizionale e con bordino dello stesso tessuto e colore. - "Punto Cavallo": Si tratta di un'impuntura decorativa disponibile in 11 colori (vedi listino prezzi) da abbinare a piacere al tessuto scelto. Il tessuto è da selezionare fra quelli idonei. Questa finitura si fornisce con supplemento di prezzo. **Struttura-Imbottiture:** Pannello di base in multistrato, imbottitura realizzata in parte in poliuretano rigido e autoportante, che fa da struttura, e in parte in poliuretani di diverse densità, idonei ad assicurare un elevato comfort. La parte interna dello schienale e della seduta è rivestita da fibra poliestere tipo "BALL" contenuta in una fodera confezionata con tanti diversi scomparti ottenuti con numerose tramezze. Tutte le parti esterne sono invece rivestite da fibra poliestere in falda rivestita a sua volta da tela di cotone. L'imbottitura in fibra poliestere tipo "BALL" offre un comfort speciale, oltre che a donare un aspetto particolarmente vissuto proprio di questa fibra che va accettato in quanto voluto. Piedini in faggio laccati di colore nero.

**Features:** The Noe collection is a system that includes sofas as well as numerous sectional elements, corners, side elements, chaise lounge and various poufs, which, combined as desired, offer innumerable combinations. It recalls the Zoe series, first presented in 2006 and already in just a few years become an icon of design. The Noe framework is made of self-bearing polyurethane: this allows a very comfortable traditional seat without losing any of its appeal and lightness. According to upholstery cover is provided in three finishes: Visible Seams, Classical Stitching or with "Punto Cavallo" stitching. "Punto Cavallo" finish is available with up charge. Considering the shape and the characteristics of Noe we do not recommend fabrics that are too lightweight. An heavy armrest is available to be placed on the seat that offers a stable and comfortable support. Covers are completely and easily removable. The elements are supplied as standard with a practical hooking system. **Available Finishes:** - "Visible Seams": Can be provided with suitable fabrics (see price list) as well as with any kind of leather. In leather Noe is provided as standard with Visible Seams only. - "Classical Stitching": With all other fabrics we provide classical stitching with piping in the same fabric and colour. - "Punto Cavallo": Decorative stitching available in 11 colours (see price list) to be matched at pleasure with the fabric. Fabric has to be chosen among those specified as suitable. This finish is available with up charge. **Framework-Padding:** Plywood base-panel, padding made partly of rigid self-supporting polyurethane, forming the framework, and partly of polyurethane fibres in different densities, suitable to guarantee high comfort. The inside of the backrest and of the seat is covered by "BALL" type polyester fibre contained in a lining made of many different compartments obtained with numerous partitions. All the external parts are instead covered with flake polyester fibre covered, in its turn, by cotton cloth. The "BALL" type polyester padding provides special comfort, as well as giving a particularly aged appearance specific to this fibre that must be accepted as it is intentional. Black lacquered beech feet.

**Eigenschaften:** Die Kollektion Noe ist ein System aus Sofas und zahlreichen Elementen: Eckteile, Seitenteile, Chaiselongues und verschiedene Hocker, die nach eigenem Geschmack kombiniert werden können. Noe lehnt sich an das Modell Zoe an, das im Jahr 2006 vorgestellt wurde und schon jetzt zu einem Klassiker geworden ist. Die Struktur von Noe besteht aus Polyurethan; dies gewährleistet eine klassische, sehr bequeme und nicht zu stark federnde Sitzfläche. Je nach Wahl des Bezugs werden drei verschiedene Nähte genäht: Klaffnaht, Kedernaht oder die Ziernaht „Punto Cavallo“. Die Verarbeitung mit der Ziernaht „Punto Cavallo“ erfolgt gegen Aufpreis. Angesichts der charakteristischen Form von Noe wird von der Verwendung von leichter Stoffe abgeraten. Ein extra schweres, kompaktes Armlehnkissen, das auf die Sitzfläche gelegt werden kann, bietet eine bequeme und stabile Stütze. Die Kollektion Noe wird serienmäßig mit komplett abziehbaren Bezügen und mit Verbinder angeboten. **Ausführbare Nähte:** - „Klaffnaht“: wird ausnahmslos nur bei dazu geeigneten Stoffen (siehe Preisliste) und allen Lederarten verarbeitet. Die Standardausführung bei Lederbezügen ist immer mit Klaffnaht. - „Kedernaht“: Alle anderen Stoffe haben die traditionelle Naht mit Keder des gleichen Stoffes und der gleichen Farbe. - „Punto Cavallo“: Es handelt sich um einen Zierstich, der in 11 verschiedenen Farben (siehe Preisliste) realisierbar und mit dem gewählten, dafür geeigneten, Stoff kombinierbar ist. Diese Ziernaht ist gegen Aufpreis erhältlich. **Struktur und Polster:** Mehrschichtholz und Polyurethan, teilweise steif, selbsttragend und strukturbildend, teilweise in verschiedenen Dichten, sorgen für besten Komfort. Die Innenseite der Rückenlehne und die Oberseite der Sitzfläche sind mit der Polyesterfaser „BALL“ bezogen, die in einen, in einzelne Segmente geteilten Stoffbezug eingenäht ist. Die jeweiligen Außenseiten sind mit Polyesterflocken bedeckt, die ihrerseits mit Baumwollstoff bezogen sind. Die Polyesterpolsterung vom Typ „BALL“ bietet besonderen Komfort, ganz abgesehen von dem „gelebten“ Aussehen, das durch diese Faser entsteht und gewünscht ist. Die Füße sind aus schwarz lackierter Buche.

#### SEZIONE SECTION SEKTION

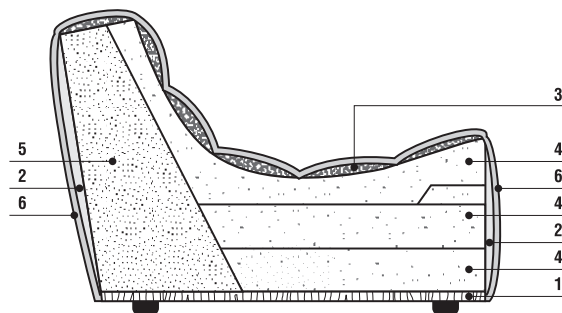

- 1: Pannello multistrato. Plywood base-panel. Mehrschichtholz.
- 2: Fibra Poliestere. Polyester Fibre. Polyesterfaser.
- 3: Fibra Poliestere Bali (insacchettata). Bali Polyester Fibre (pockets). Polyesterfaser "Bali" (beutelartig).
- 4: Poliuretano a densità differenziata. Differentiated density polyurethane. Polyurethan unterschiedlicher Dichte.
- 5: Poliuretano rigido autoportante. Self-supporting rigid polyurethane. Selbsttragendes steifes Polyurethan.
- 6: Fodera in tela. Fabric lining. Schonbezug.

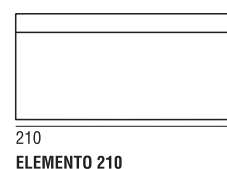
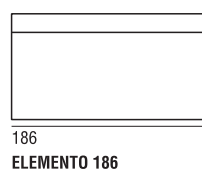
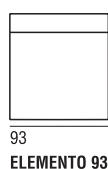
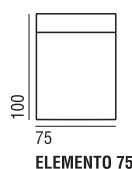
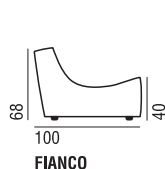

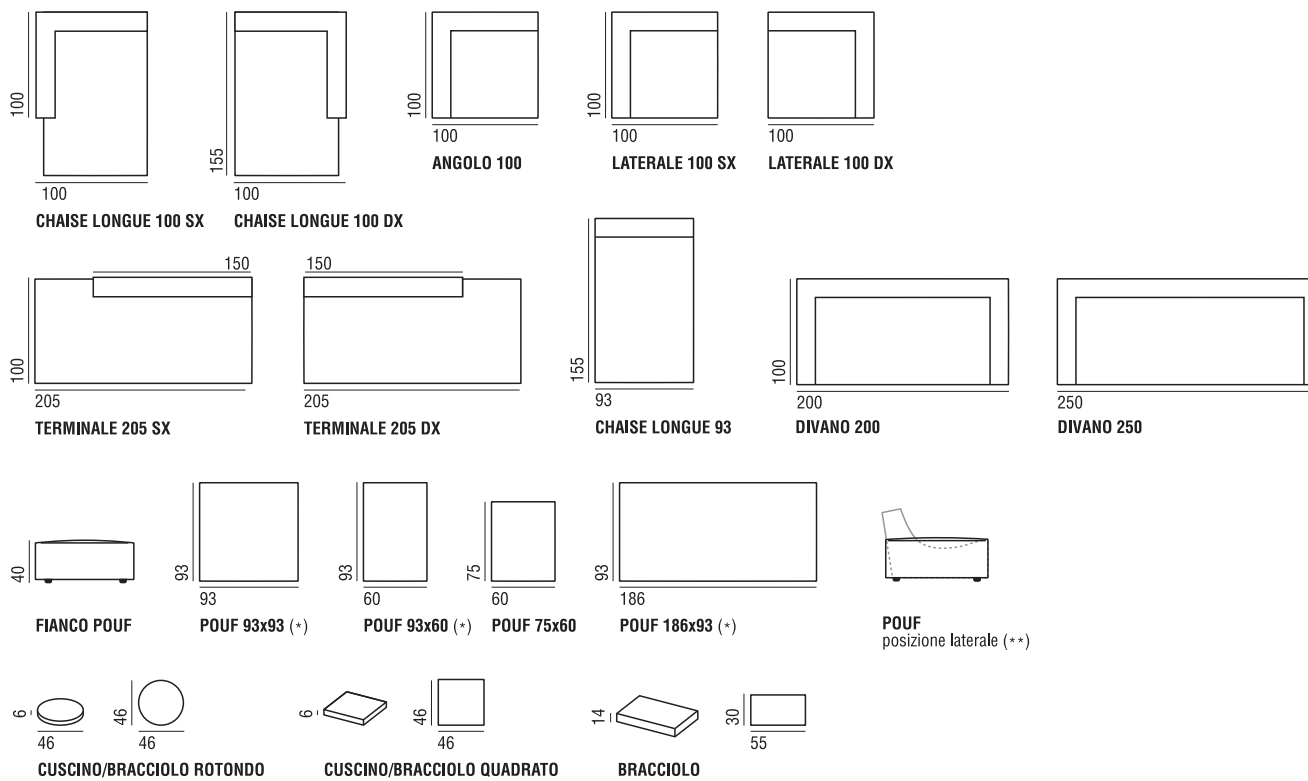





**Caratteristiche:** Joe è un sistema di moduli con speciali caratteristiche di componibilità, disponibile in due altezze di schienale: versione Alta (H.cm 83) composta da 10 elementi di diverse profondità e larghezze e versione Bassa (H. cm 68) composta da 10 elementi. A completare il sistema 6 pouf in varie misure. La versione Alta offre un'elevata comodità consentendo di appoggiare la testa. La peculiarità di questo componibile consiste nella possibilità di accostare i vari moduli tra di loro non solo lateralmente, ma anche frontalmente (fianco con fronte) in quanto la misura di ogni fianco è disponibile anche come misura frontale. Pur potendo affiancare direttamente fra loro elementi Alti e Bassi, bisogna tenere conto di una leggera differenza nel profilo interno dello schienale, mentre esternamente è perfettamente allineato: è quindi consigliabile interporre dei pouf fra elementi Alti e Bassi. Le combinazioni possibili sono veramente illimitate per un utilizzo personale e libero da condizionamenti. La linea è contrassegnata dalla morbida presenza della piuma nelle imbottiture interne che crea un piacevole contrasto con l'esterno volutamente pulito e compatto. Particolare piacevole è la finitura posta lateralmente che nasconde la cerniera per consentire una facile e completa sfoderabilità. Joe si può attrezzare con un bracciolo completo di cuscino in piuma. Il bracciolo può essere installato anche successivamente, a piacimento e su ogni elemento, grazie al pratico sistema di aggancio che ne consente il montaggio sia a destra che a sinistra. Il bracciolo si può ottenere anche con i tavolini Jules e Jim creati appositamente come piani di appoggio che, se completati dal cuscino bracciolo, offrono un comodo sostegno. Pratici agganci consentono di assemblare fra loro tutti i moduli del sistema Joe a seconda della composizione che si desidera ottenere. Joe può essere corredato con cuscini in piuma cm.40x60 (di serie solo nella versione Alta XL) oppure di cm. 40x40. **Struttura:** Fusto in legno massello e multistrato, bracciolo con struttura in metallo imbottito in poliuretano e cuscino d'appoggio in piuma. Piedini ABS nero. **Imbottitura:** Schienali e sedili sono imbottiti in poliuretano espanso a densità differenziata e con una materassina in piuma a scomparti separati, successivamente rivestiti da una fibra poliestere. Il sedile ha il molleggio con nastri elastici. Prerivestimento in tela. **Tavolini Jules e Jim:** In legno listellare impiallacciato rovere tinto naturale leggermente sbiancato oppure tinto wengé.

**Features:** Joe is a module system with special modularity features. Joe is available in two backrest heights: High version (H. 83 cm) consisting of ten items of various depths and widths, and Low version (H. 68 cm) consisting of ten items. The system is completed by six poufs of various sizes. The High version provides a high comfort level and allows resting the head. The special feature of this modular unit is the possibility of matching the various modules not only on the sides, but also on the front (side with front), as the size of each side is also available as front size. Although it is possible to put directly High and Low items side by side, a slight difference in the internal profile of the backrest should be considered, while it is perfectly aligned externally. Therefore, it is advisable to put poufs between High and Low items. This system allows countless possible combinations for personal use free from any conditioning. The line is marked by the soft down in internal padding, which creates a pleasant contrast with the intentionally lean and compact outside. A pleasant item is the side finish, which hides the zipper for easy and full removal of covers. Joe can be provided with an armrest with down cushion. The armrest can also be installed subsequently, at will and on all items, through its practical hooking system, which allows its positioning on the right and left. The armrest can also be obtained with tables Jules and Jim, which have been specifically created as supports; if they are provided with armrest cushions, they provide a comfortable support. Practical hooks allow assembling all modules of the Joe system, based on the composition to be obtained. Joe can be provided with small down cushions 40x60 cm (standard only in the High XL version) or 40x40 cm. **Structure:** The frame is made of solid wood and plywood; the armrest metal frame is padded with polyurethane and provided with down cushion. Feet in ABS black colouring. **Cushion padding:** Backrests and seat cushions are padded with expanded polyurethane with differentiated density and separate down mat, and covered with polyester fibre. The seat cushion is sprung with elastic belts. The under-cover is made of lining. **Tables Jules and Jim:** Laminwood and veneered oak, natural slightly bleached colour, or wengé colour.

**Eigenschaften:** Joe ist ein System von Modulen mit speziellen Charakteristika zur Zusammenstellung, erhältlich mit einer Rückenlehne in zwei Höhen: eine höhere Variante (Variante Alta, H: 83 cm) bestehend jeweils aus 10 Elementen unterschiedlicher Tiefe und Breite und eine niedrigere Variante (Variante Bassa, H: 68 cm), bestehend aus 10 Elementen. 6 Hocker in unterschiedlicher Größe komplettieren das Programm. Die Variante Alta bietet erhöhten Komfort, indem sie das Anlehnen des Kopfes erlaubt. Die eigentliche Besonderheit des Systems besteht in der Möglichkeit, die unterschiedlichen Module untereinander nicht nur seitlich, sondern auch frontal zu verbinden, da jede Breiten sowohl frontal als auch seitlich eingesetzt werden kann. Bei der direkten Verbindung der Elemente Alta und Bassa muss man mit einem leichten Unterschied im inneren Profil der Rückenlehne rechnen, während die äußere Form der unterschiedlichen Elemente perfekt harmoniert, und so kann man auch die Hocker zwischen die Elemente Alta und Bassa integrieren. Die so möglichen Kombinationen sind wirklich unbegrenzt, je nach persönlichem Geschmack und Gestaltungswillen. Die Form ist durch die Weichheit der innen liegenden Daunen gekennzeichnet, die einen angenehmen Kontrast mit dem klaren und kompakten Äußeren bildet. Besonders angenehm ist die seitliche Begrenzung, die aus dem Reissverschluss entspringt, der einen einfachen und kompletten Abzug des Bezugs ermöglicht. Joe kann mit einer Armlehne ausgestattet werden, die über eine Federschicht verfügt. Die Armlehne kann auch nachträglich hinzugefügt werden, nach Bedarf und zu jedem Modul passend. Dies ist aufgrund eines praktischen Verbindungsmechanismus möglich, der die Montage sowohl links als auch rechts erlaubt. Armlehnen sind auch mit den Beistelltischen Jules und Jim zu erreichen, die einen Ablagefläche bilden und, wenn sie mit einem Armlehnenkissen ausgestattet werden, einen angenehmen Halt bieten. Praktische Verbindungsmechanismen erlauben es, alle Module von Joe miteinander zu kombinieren und so die individuell gewünschte Zusammenstellung zu erreichen. Für Joe sind Daunenkissen der Größe 40 x 60 cm (standardmäßig nur in der Variante Alta XL) oder 40 x 40 cm verfügbar. **Struktur:** Gestell aus gemasertem Schichtholz, Armlehnen aus mit Polyurethan ummanteltem Metall und Stützkissen aus Daunen. Füße aus ABS schwarz. **Polsterung:** Rückenlehne und Sitze aus Polyurethan unterschiedlicher Dichte mit einer Lage in Kammern gesteppter Federn und mit Polyesterfaser ummantelt. Der Sitz ist mit elastischen Gurten gefedert. Schonbezug. **Beistelltische Jules und Jim:** In Edelloch furniert, in Eiche lackiert, gebleicht oder in Wengé.

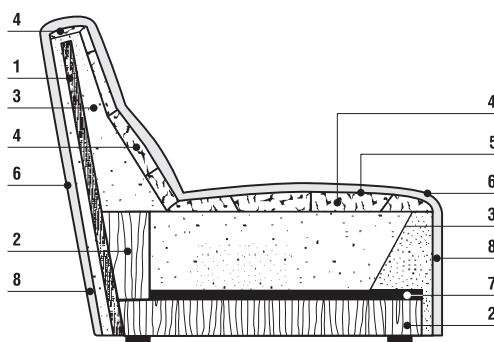

#### SEZIONE SECTION SEKTION

- 1: Pannello multistrato. Plywood base-panel. Mehrschichtholz.
- 2: Fusto in legno massello e multistrato. Frame in solid wood and plywood. Korpus aus Massivholz, oder schichtverleimt.
- 3: Poliuretano a densità differenziata. Differentiated density polyurethane. Polyurethan unterschiedlicher Dichte.
- 4: Piuma. Down. Federfüllung.
- 5: Fodera in tessuto antipiuma. Featherproof fabric cover. Federnunddurchlässiger Bezug des Kisseninlets.
- 6: Fodera in tela. Fabric lining. Schonbezug.
- 7: Nastri elastici. Elastic belts. Elastische Gurte.
- 8: Fibra Poliestere. Polyester Fibre. Polyesterfaser.

MODULI ALTI (A) / PROFONDITÀ 101 cm - HIGH MODULES (A) / DEPTH 101 cm - HÖHERE MODULEN (A) / TIEFE 101 cm

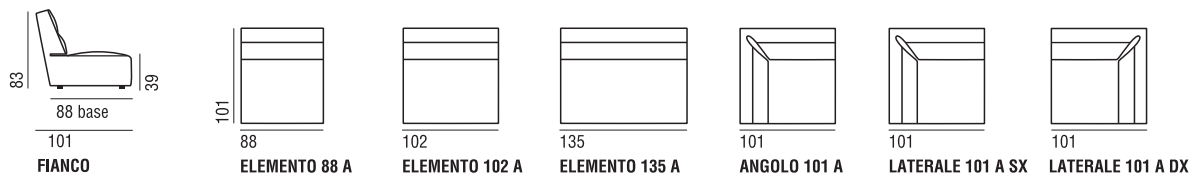

MODULI ALTI (A XL) / PROFONDITÀ 115 cm / COMPLETI DI CUSCINI SCHIENALI - HIGH MODULES (A XL) / DEPTH 115 cm / BACKREST CUSHIONS INCLUDED - HÖHERE MODULEN (A XL) / TIEFE 115 cm / INKLUSIVE RÜCKENKISSEN

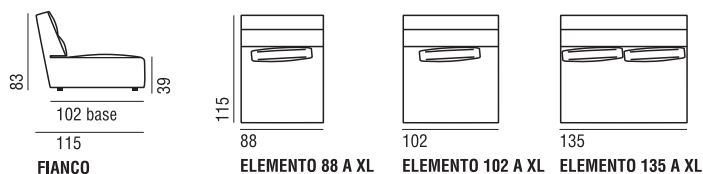

MODULI ALTI / PROFONDITÀ 148 cm (CHAISE LONGUE A) - HIGH MODULES / DEPTH 148 cm (CHAISE LONGUE A) - HÖHERE MODULEN / TIEFE 148 cm (CHAISE LONGUE A)

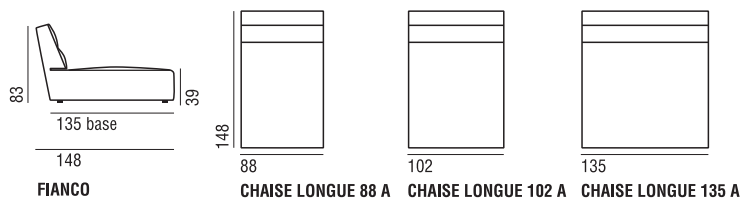

MODULI BASSI (B) / PROFONDITÀ 98 cm - LOW MODULES (B) / DEPTH 98 cm - NIEDRIGE MODULEN (B) / TIEFE 98 cm

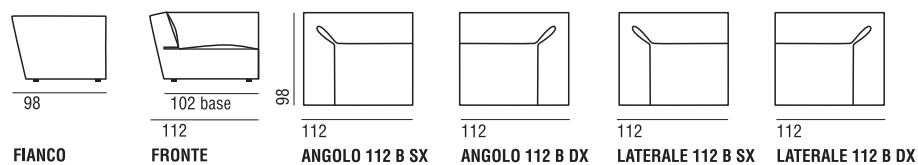
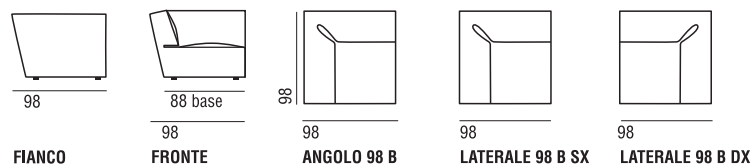
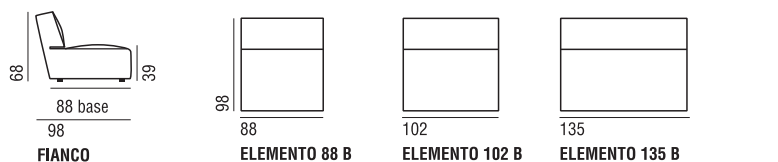

ESEMPIO ACCOSTAMENTO TRA DUE ELEMENTI FIANCO CONTRO FRONTE / EXAMPLE OF MATCHING BETWEEN TWO ITEMS SIDE AGAINST FRONT / BEISPIELHAFTE KOMBINATION VON ZWEI ELEMENTEN IN FRONT- UND SEITENSANSICHT

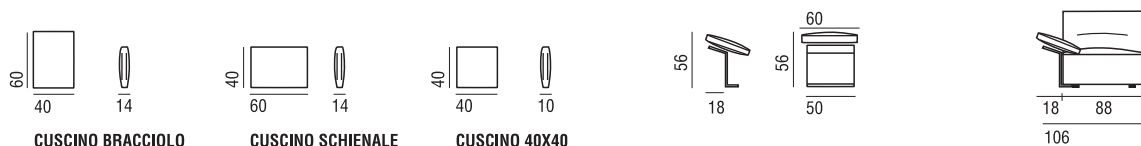
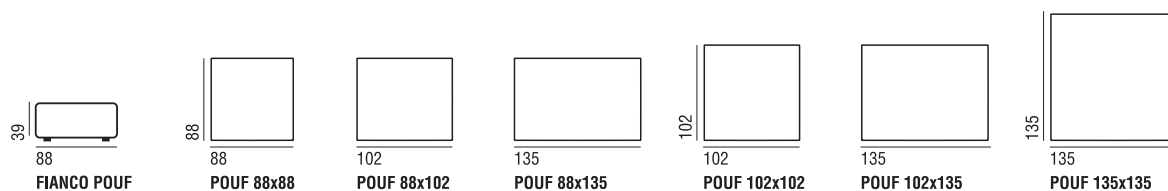
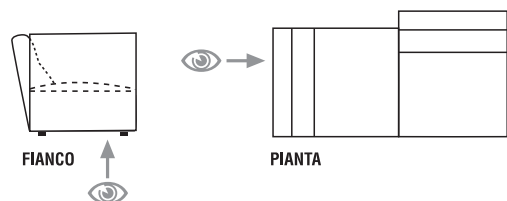

bracciolo completo di cuscino-bracciolo ambidestro  
armrest provided with cushion - Ambidextrous armrest  
Armlehne komplett mit Armlehn-Polster für Armlehne

esempio bracciolo su elemento 88  
example of armrest on item 88  
Beispiel für Armlehne zusammen mit Element 88

COMPLEMENTI

TAVOLINO JIM design Lievore Altherr Molina (2010)

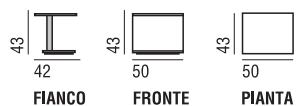

TAVOLINO JULES design Lievore Altherr Molina (2010)

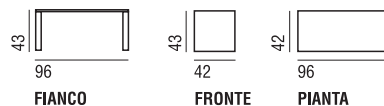

idoneo per appoggio su pouf con un lato di 88 cm / appropriate for support on pouf with 88 cm side  
Einsetzbar als Auflage für einen Pouf mit einer Breite von 88 cm



**Caratteristiche:** Linea essenziale, elegante e molto confortevole offre un ventaglio di divani ed elementi accostabili che, abbinati liberamente, creano infinite possibilità di combinazioni grazie ai 138 moduli a disposizione. Tutti i divani e gli elementi sono disponibili nella profondità da cm.96 e molti anche nella profondità da cm.116 (XL). Link offre inoltre la possibilità di scegliere tra due differenti versioni di schienali, una classica (A) e l'altra con accattivanti schienali-guanciali (B). Link è inoltre disponibile con abito "teso" oppure con gonna (Link Classic), ed è possibile accostare fra di loro le due diverse profondità come anche le due diverse versioni di schienali al fine di ottenere composizioni estremamente personalizzate. Il rivestimento è completamente e facilmente sfoderabile. **Struttura:** Fusto in legno massello e multistrato, imbottito in poliuretano espanso indeformabile a densità differenziata, molleggio con nastri elastici intrecciati. Prerivestimento con tela di cotone accoppiata con fibra poliestere. Piedini in frassino tinto wengé o tinto rovere oppure acciaio satinato. **Imbottiture cuscini:** Tutte le imbottiture sono interamente prerivestite con tela bianca. Schienali versione A in piuma lavata e sterilizzata con inserto in poliuretano indeformabile che garantisce la comodità e la compostezza dell'imbottitura; schienali versione B interamente in piuma. Cuscini seduta in poliuretano a densità differenziata più fibra poliestere.

**Features:** Minimalist, elegant and extremely comfortable settees and elements that combine freely in an infinite number of possibilities thanks to the 138 modules available. Settees and elements are available with depths of 96 cm. and 116 cm (XL). Link offers also the possibility to choose between two different backrest models: the classical backrest (A) or the charming one with cushion-backrest (B). Link is also available with "taut" cover or with skirting (Link Classic), and it is possible to match the two different depths and the two different backrest models as well, to obtain extremely customized compositions. The cover is completely and easily removable. **Structure:** Frame made of solid wood and plywood padded with non-deformable differentiated density expanded polyurethane, sprung with elastic belts. Lining with cotton fabric coupled with polyester fibre. Feet are made of wengé-colour ash, oak-colour ash or satin-finish steel. **Cushion padding:** All the padding is fully lined with white fabric. Backrests Model A - filled with washed and sterilized down with non-deformable polyurethane insert guaranteeing comfortable and firm padding, backrests Model B - completely filled with down. Seat cushions with differentiated density polyurethane plus Polyester fibre.

**Eigenschaften:** Nüchternes Design, elegant und sehr komfortabel. Durch ein breites Spektrum an Sofas und kombinierbaren Elementen, bietet es durch die 138 Module eine Unzahl an Möglichkeiten zur freien Gestaltung. Die Sofas und die Elemente sind mit einer Tiefe von 96 cm, viele davon auch mit einer Tiefe von 116 cm. (XL) lieferbar. Bei Link hat man auch die Wahl zwischen zwei Rückenlehnen: eine klassische Rückenlehne (A), und ein besonders ansprechende Wurfkissen (B). Link ist außerdem sowohl mit gespanntem Stoffüberzug als auch mit Volant lieferbar (Link Classic). Es ist auch möglich, zwei verschiedene Tiefen und zwei verschiedene Rückenlehnen aneinander zu stellen, um eine durchaus persönliche Zusammenstellung zu erhalten. Der Bezug ist komplett und einfach abziehbar. **Struktur:** Korpus aus Massivholz und Mehrschichtholz, gepolstert mit formstabilem Polyurethan mit unterschiedlicher Dichte, Federung durch Elastikgurte. Schonbezug aus Baumwolle mit Polyesterfaser. Füße aus Eschenholz, wengé- oder eichenfarben gebeizt, oder aus satiniertem Edelstahl. **Kissenpolsterung:** Alle Polster sind mit einem weißen Schonbezug versehen. Rückenpolster aus gewaschenen und sterilisierten Daunen mit formstabilem Polyurethankingern, welcher der Polsterung Komfort und Festigkeit verleiht. Sitzkissen aus Polyurethan mit unterschiedlicher Dichte plus Polyesterfaser.

#### PIEDE FOOT FUß

Massello di frassino tinto rovere o tinto wengé.  
Solid ashwood stained oak or wengé.  
Esche massiv, eichen- oder wengenhholzgebeizt.



Acciaio satinato.  
Satin-finish steel.  
Satiniertier Edelstahl.

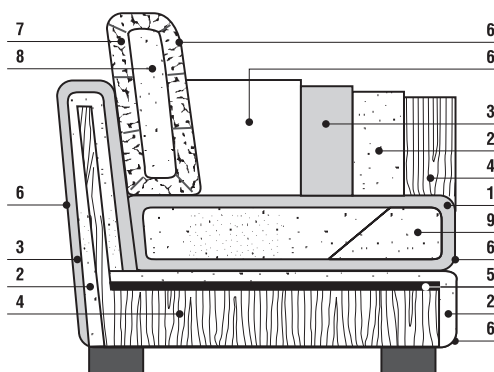

#### SEZIONE SECTION SEKTION

- 1: Fibra Poliestere. Polyester Fibre. Polyesterfaser.
- 2: Poliuretano. Polyurethane. Polyurethan.
- 3: Fibra Poliestere. Polyester Fibre. Polyesterfaser.
- 4: Fusto in legno massello e multistrato.  
Frame in solid wood and plywood.  
Korpus aus Massiv- schichtverleimtem Holz.
- 5: Nastri elastici. Elastic belts. Elastische Gurte.
- 6: Fodera in tela. Fabric lining. Schonbezug.
- 7: Piuma. Down. Federfüllung.
- 8: Inserto in Poliuretano. Polyurethane insert.  
Einsatz aus Polyurethan.
- 9: Poliuretano a densità differenziata.  
Differentiated density polyurethane.  
Polyurethan mit unterschiedlicher Dichte.

#### LINK VERSIONE A / profondità 96 cm.

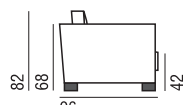

FIANCO 96 A

#### LINK VERSIONE B / profondità 96 cm.



FIANCO 96 B

#### LINK VERSIONE XL A / profondità 116 cm.

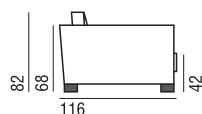

FIANCO 116 XL A

#### LINK VERSIONE XL B / profondità 116 cm.

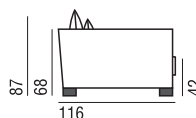

FIANCO 116 XL B

**LINK VERSIONE A / profondità 96 cm.**

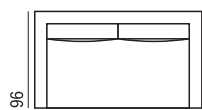

169  
**DIVANO 169 A**  
cuscino unico

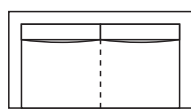

193  
**DIVANO 193 A**  
cuscino unico / cuscini divisi

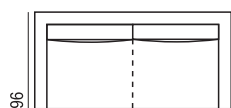

218  
**DIVANO 218 A**  
cuscino unico / cuscini divisi

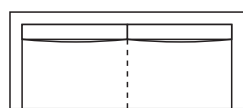

248  
**DIVANO 248 A**  
cuscino unico / cuscini divisi

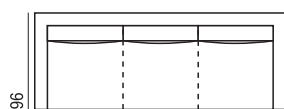

273  
**DIVANO 273 A**  
cuscino unico / cuscini divisi

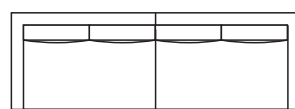

304  
**DIVANO 304 A** (composto da 2 laterali 152 A)  
2 cuscini



124  
**LATERALE 124 SX A**  
cuscino unico

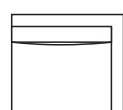

124  
**LATERALE 124 DX A**  
cuscino unico

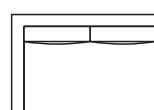

152  
**LATERALE 152 SX A**  
cuscino unico

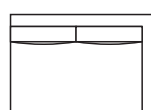

152  
**LATERALE 152 DX A**  
cuscino unico

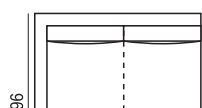

176  
**LATERALE 176 SX A**  
cuscino unico / cuscini divisi

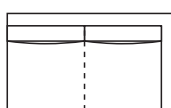

176  
**LATERALE 176 DX A**  
cuscino unico / cuscini divisi

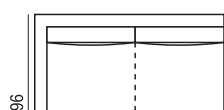

201  
**LATERALE 201 SX A**  
cuscino unico / cuscini divisi

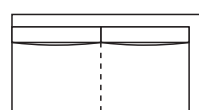

201  
**LATERALE 201 DX A**  
cuscino unico / cuscini divisi

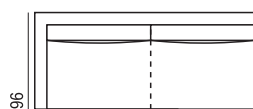

231  
**LATERALE 231 SX A**  
cuscino unico / cuscini divisi

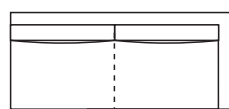

231  
**LATERALE 231 DX A**  
cuscino unico / cuscini divisi

**LINK VERSIONE B / profondità 96 cm.**

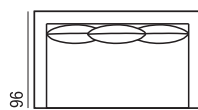

169  
**DIVANO 169 B**  
cuscino unico

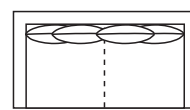

193  
**DIVANO 193 B**  
cuscino unico / cuscini divisi

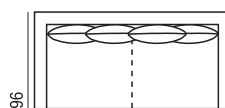

218  
**DIVANO 218 B**  
cuscino unico / cuscini divisi

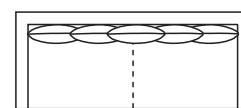

248  
**DIVANO 248 B**  
cuscino unico / cuscini divisi

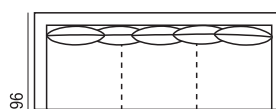

273  
**DIVANO 273 B**  
cuscino unico / cuscini divisi

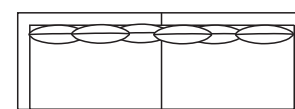

304  
**DIVANO 304 B** (composto da 2 laterali 152 B)  
2 cuscini

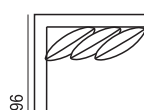

124  
**LATERALE 124 SX B**  
cuscino unico

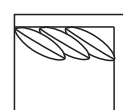

124  
**LATERALE 124 DX B**  
cuscino unico

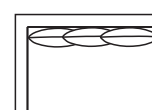

152  
**LATERALE 152 SX B**  
cuscino unico

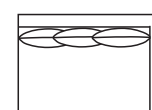

152  
**LATERALE 152 DX B**  
cuscino unico

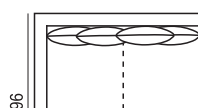

176  
**LATERALE 176 SX B**  
cuscino unico / cuscini divisi

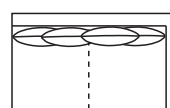

176  
**LATERALE 176 DX B**  
cuscino unico / cuscini divisi

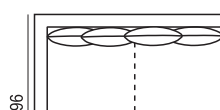

201  
**LATERALE 201 SX B**  
cuscino unico / cuscini divisi

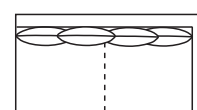

201  
**LATERALE 201 DX B**  
cuscino unico / cuscini divisi

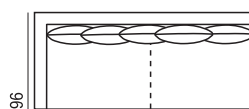

231  
**LATERALE 231 SX B**  
cuscino unico / cuscini divisi

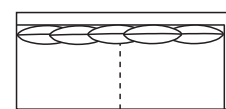

231  
**LATERALE 231 DX B**  
cuscino unico / cuscini divisi

**LINK VERSIONE A / profondità 96 cm.**

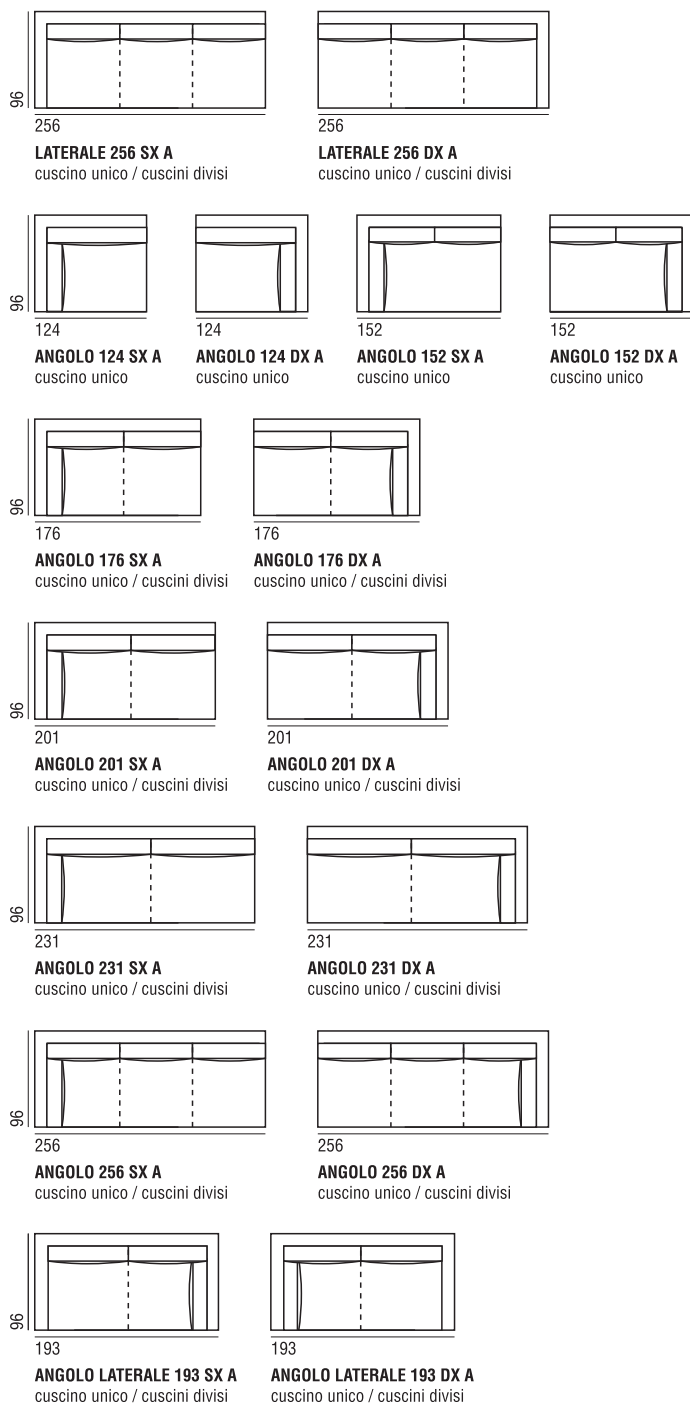

**LINK VERSIONE B / profondità 96 cm.**

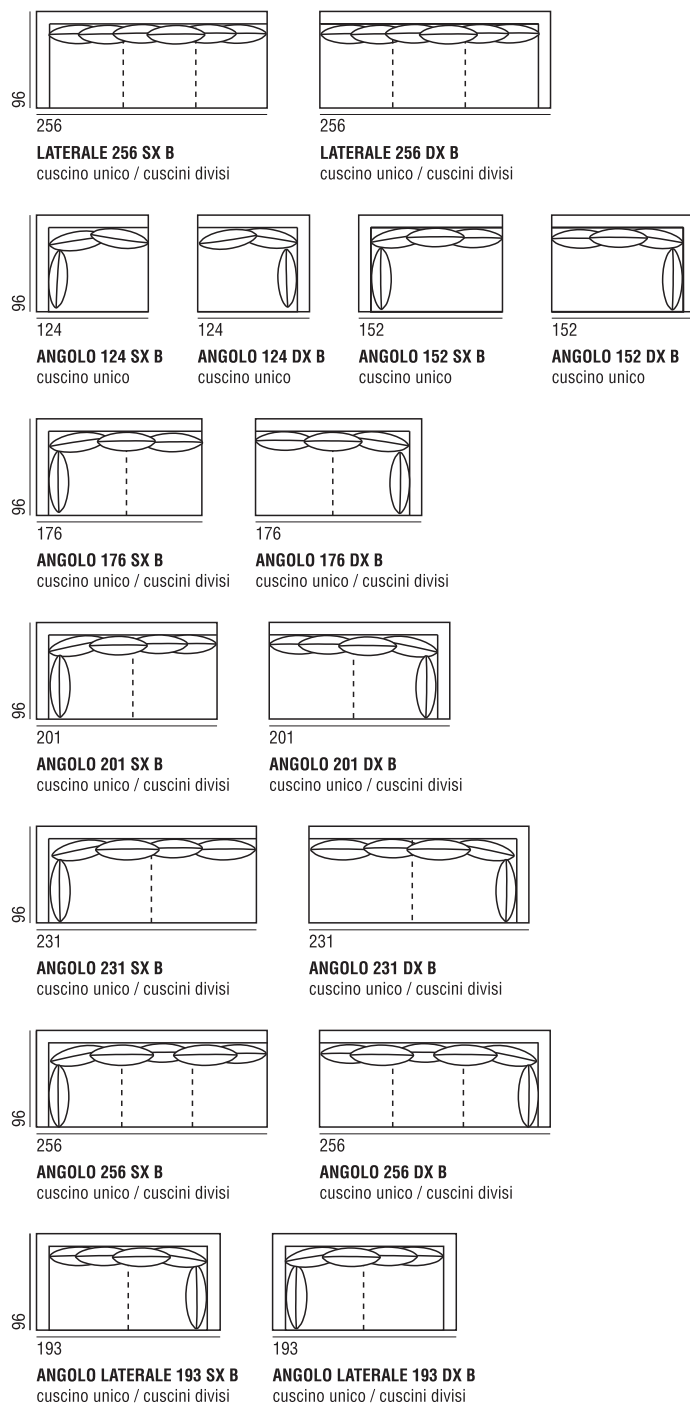

**LINK VERSIONE A / profondità 96 cm.**

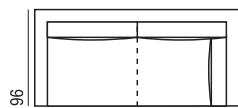

218  
**ANGOLO LATERALE 218 SX A**  
cuscino unico / cuscini divisi

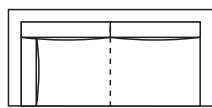

218  
**ANGOLO LATERALE 218 DX A**  
cuscino unico / cuscini divisi

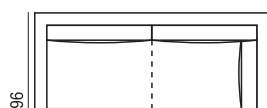

248  
**ANGOLO LATERALE 248 SX A**  
cuscino unico / cuscini divisi

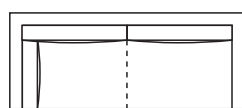

248  
**ANGOLO LATERALE 248 DX A**  
cuscino unico / cuscini divisi

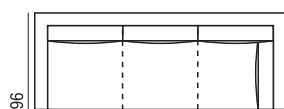

273  
**ANGOLO LATERALE 273 SX A**  
cuscino unico / cuscini divisi

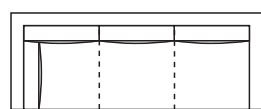

273  
**ANGOLO LATERALE 273 DX A**  
cuscino unico / cuscini divisi

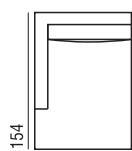

154  
96  
**CHAISE LONGUE 96 SX A**

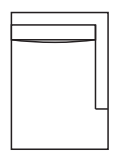

154  
96  
**CHAISE LONGUE 96 DX A**

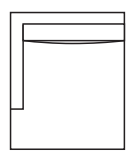

154  
124  
**CHAISE LONGUE 124 SX A**

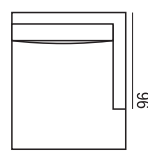

154  
124  
**CHAISE LONGUE 124 DX A**

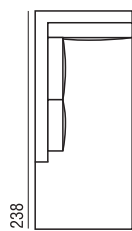

238  
96  
**DORMEUSE 238 SX A**

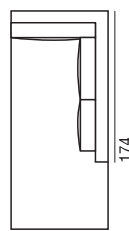

238  
96  
**DORMEUSE 238 DX A**

**LINK VERSIONE B / profondità 96 cm.**

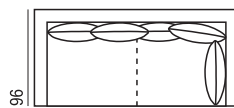

218  
**ANGOLO LATERALE 218 SX B**  
cuscino unico / cuscini divisi

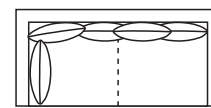

218  
**ANGOLO LATERALE 218 DX B**  
cuscino unico / cuscini divisi

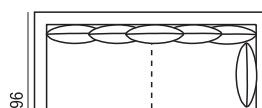

248  
**ANGOLO LATERALE 248 SX B**  
cuscino unico / cuscini divisi

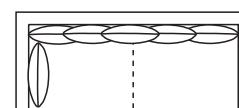

248  
**ANGOLO LATERALE 248 DX B**  
cuscino unico / cuscini divisi

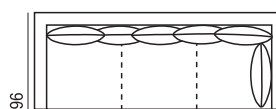

273  
**ANGOLO LATERALE 273 SX B**  
cuscino unico / cuscini divisi

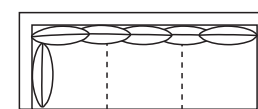

273  
**ANGOLO LATERALE 273 DX B**  
cuscino unico / cuscini divisi

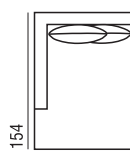

154  
96  
**CHAISE LONGUE 96 SX B**

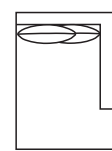

154  
96  
**CHAISE LONGUE 96 DX B**

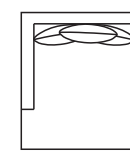

154  
124  
**CHAISE LONGUE 124 SX B**

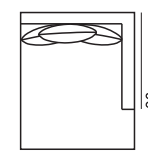

154  
124  
**CHAISE LONGUE 124 DX B**

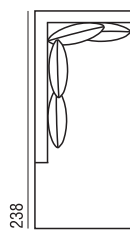

238  
96  
**DORMEUSE 238 SX B**

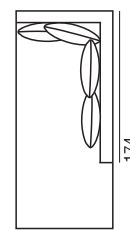

238  
96  
**DORMEUSE 238 DX B**

**LINK VERSIONE XL A / profondità 116 cm.**

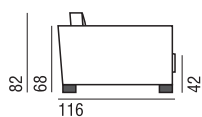

**FIANCO 116 XL A**

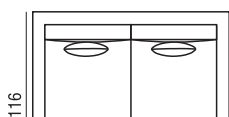

**DIVANO 218 XL A**  
cuscini divisi

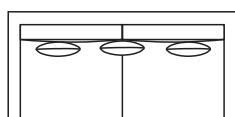

**DIVANO 248 XL A**  
cuscini divisi

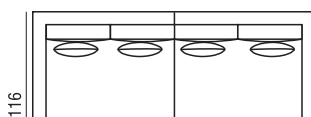

**DIVANO 304 XL A** (composto da 2 laterali 152 XL A)  
2 cuscini

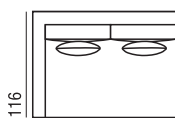

**LATERALE 152 XL SX A**  
cuscino unico

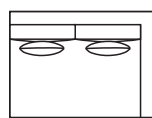

**LATERALE 152 XL DX A**  
cuscino unico

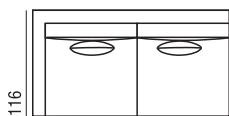

**LATERALE 201 XL SX A**  
cuscini divisi

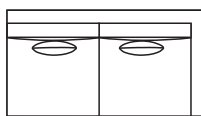

**LATERALE 201 XL DX A**  
cuscini divisi

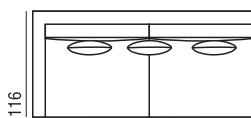

**LATERALE 231 XL SX A**  
cuscini divisi

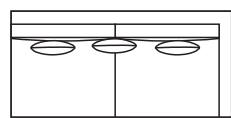

**LATERALE 231 XL DX A**  
cuscini divisi

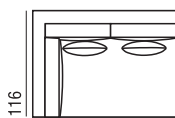

**ANGOLO 152 XL SX A**  
cuscino unico

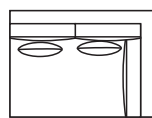

**ANGOLO 152 XL DX A**  
cuscino unico

**LINK VERSIONE XL B / profondità 116 cm.**

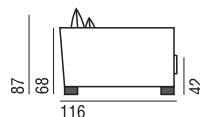

**FIANCO 116 XL B**

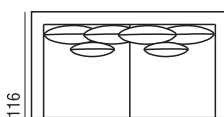

**DIVANO 218 XL B**  
cuscini divisi

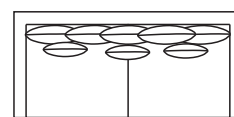

**DIVANO 248 XL B**  
cuscini divisi

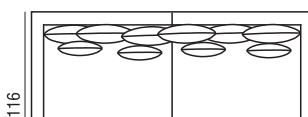

**DIVANO 304 XL B** (composto da 2 laterali 152 XL B)  
2 cuscini

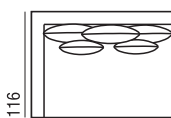

**LATERALE 152 XL SX B**  
cuscino unico

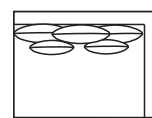

**LATERALE 152 XL DX B**  
cuscino unico

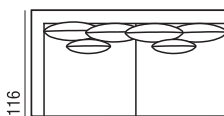

**LATERALE 201 XL SX B**  
cuscini divisi

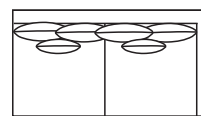

**LATERALE 201 XL DX B**  
cuscini divisi

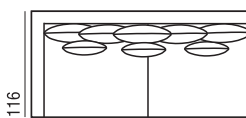

**LATERALE 231 XL SX B**  
cuscini divisi

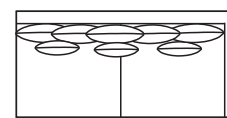

**LATERALE 231 XL DX B**  
cuscini divisi

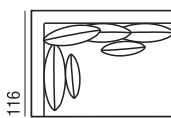

**ANGOLO 152 XL SX B**  
cuscino unico

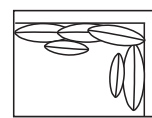

**ANGOLO 152 XL DX B**  
cuscino unico



**LINK VERSIONE XL A / profondità 116 cm.**

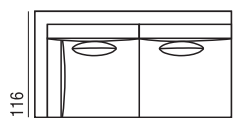

201  
**ANGOLO 201 XL SX A**  
cuscini divisi

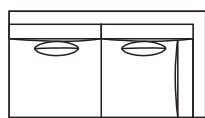

201  
**ANGOLO 201 XL DX A**  
cuscini divisi

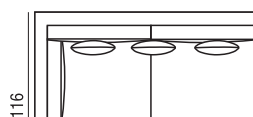

231  
**ANGOLO 231 XL SX A**  
cuscini divisi

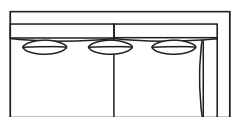

231  
**ANGOLO 231 XL DX A**  
cuscini divisi

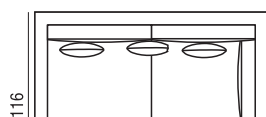

248  
**ANGOLO LATERALE 248 XL SX A**  
cuscini divisi

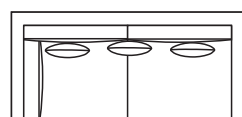

248  
**ANGOLO LATERALE 248 XL DX A**  
cuscini divisi

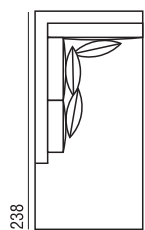

116  
**DORMEUSE 238 XL SX A**

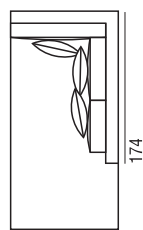

116  
**DORMEUSE 238 XL DX A**

**LINK VERSIONE XL B / profondità 116 cm.**

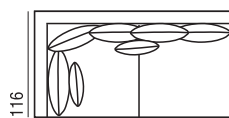

201  
**ANGOLO 201 XL SX B**  
cuscini divisi

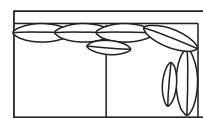

201  
**ANGOLO 201 XL DX B**  
cuscini divisi

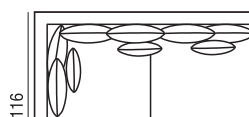

231  
**ANGOLO 231 XL SX B**  
cuscini divisi

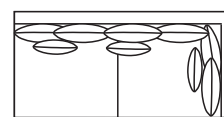

231  
**ANGOLO 231 XL DX B**  
cuscini divisi

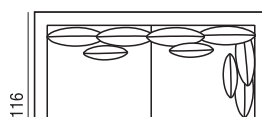

248  
**ANGOLO LATERALE 248 XL SX B**  
cuscini divisi

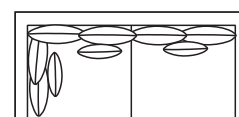

248  
**ANGOLO LATERALE 248 XL DX B**  
cuscini divisi

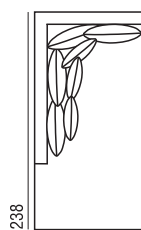

116  
**DORMEUSE 238 XL SX B**

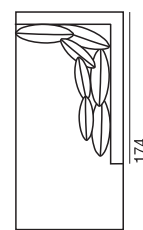

116  
**DORMEUSE 238 XL DX B**



**FIANCO POUF**



**POUF 60**

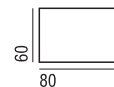

**POUF 60/80**



**POUF 136**

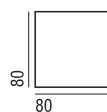

**POUF 80**

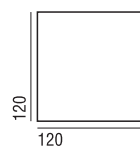

**POUF 120**



**POGGIATESTA**



**GUANCIALE SCHIENALE GRANDE**



**GUANCIALE SCHIENALE PICCOLO**



**CUSCINO**



**Caratteristiche:** Elliot è un programma di imbottiti studiato per offrire il massimo comfort non solo ergonomico ma anche visivo. La morbida presenza della piuma nelle imbottiture contrasta piacevolmente con la linea esterna volutamente più tesa e compatta. Il programma comprende elementi, laterali e divani di diverse misure, oltre all'angolo, una chaise longue e poufs di varie dimensioni e con diverse funzioni, che consentono di ottenere innumerevoli combinazioni. Può essere corredato con cuscini in piuma (cm 42x42). Il rivestimento è completamente sfoderabile. Elliot è inoltre attrezzabile con il tavolino Argo. **Struttura:** Braccioli, schienali e sedili sono componenti indipendenti che vengono fissati a una struttura metallica verniciata che fa da base e da supporto; questo consente di smontare e rimontare, in modo semplice e rapido, i vari componenti, facilitandone la sfoderabilità e il trasporto. Braccioli, schienali e sedili hanno una struttura in legno multistrato e massello. **Imbottitura:** Braccioli, schienali e sedili sono imbottiti in poliuretano espanso a densità differenziata e con una materassina di piuma a settori, successivamente rivestiti da una fibra poliestere. Il sedile ha il molleggio con nastri elastici. Prerivestimento in maglino di nylon.

**Features:** Elliot is a range of upholstered furniture designed to offer maximum comfort, not only ergonomically, but also visually. The presence of soft down in the padding pleasantly contrasts with a purposely more clear-cut and compact exterior. The range includes elements, side pieces and sofas in various sizes, as well as corners, a chaise longue and various sizes of poufs for a wide range of uses, enabling an infinite number of combinations. It can be supplied with down cushions (cm 42x42). The covers are fully removable. Besides, Elliot can be equipped with the small table Argo. **Structure:** Armrests, backrests and seats are independent elements fixed to a varnished metal structure that acts as a base and support; this allows the different components to be taken apart and reassembled simply and rapidly, making the removal of covers and transport easier. Armrests, backrests and seats have a multi-layered wood and solid wood structure. **Cushion padding:** The armrests, backrests and seats are padded in differentiated density expanded polyurethane with separate down mat, and covered with polyester fibre. The seat is sprung with elastic belts. The under-cover is made in a nylon fabric.

**Eigenschaften:** Elliot ist ein Polstermöbelprogramm, das entwickelt wurde, um maximalen ergonomischen und sichtbaren Komfort zu erreichen. Die weichen Federn in den Polstern bilden einen angenehmen Gegensatz zu der äußerlich gewollt prallen und kompakten Linie. Das Programm umfasst Elemente, Seitenteile und Sofas verschiedener Größen, außerdem Eckelemente, eine Chaiselongue und Hocker mit verschiedenen Abmessungen und Funktionen, mit denen unzählige Kombinationen möglich sind. Die Polstermöbel können mit Federkissen (42 x 42 cm) bereichert werden. Der Bezug ist komplett abziehbar. Elliot kann ebenfalls mit dem kleinen Beistelltisch Argo ergänzt werden. **Struktur:** Armlehnen, Rückenlehnen und Sitzflächen sind voneinander unabhängige Elemente, die an einem lackiertem Metallgestell, das als Basis und Träger gilt, befestigt sind. Diese Unabhängigkeit ermöglicht eine mühelose Demontage und Montage der verschiedenen Bestandteile, was wiederum die Abziehbarkeit und den Transport erleichtert. Armlehnen, Rückenlehnen und Sitzflächen haben eine Struktur aus Mehrschichtholz und Massivholz. **Polsterung:** Armlehnen, Rückenlehnen und Sitze sind aus formstabilem Polyurethan mit unterschiedlicher Dichte und mit einer Federschichtmatratze und Polyesterfaser bezogen. Die Sitzfläche ist mit Elastikgurten gefedert. Schonbezug aus Nylongewebe.

**BASE BASE UNTERBAU**

Metallo verniciato color scuro.  
Dark painted metal.  
Dunkel lackiertes Metallgerüst.

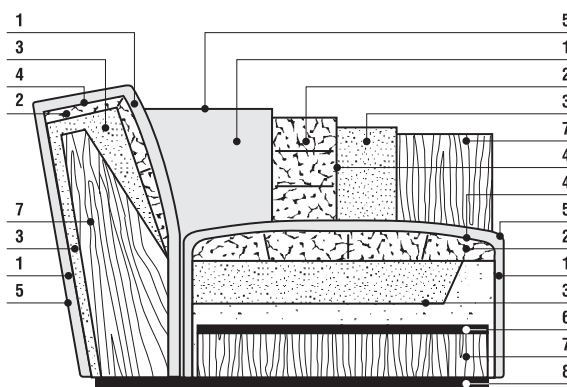

**SEZIONE SECTION SEKTION**

- 1: Fibra Poliestere. Polyester Fibre. Polyesterfaser.
- 2: Piuma. Down. Federfüllung.
- 3: Poliuretano a densità differenziata.  
Differentiated density polyurethane.  
Polyurethan unterschiedlicher Dichte.
- 4: Fodera in tessuto antipiuma.  
Featherproof fabric cover.  
Federnundurchlässiger Bezug des Kisseninlets.
- 5: Fodera in maglina di nylon.  
Fabric. nylon fabric. Schonbezug.
- 6: Nastri elastici. Elastic belts. Elastische Gurte.
- 7: Fusto in legno massello e multistrato.  
Frame in solid wood and plywood.  
Korpus aus Massiv- und schichtverleimtem Holz.
- 8: Base - supporto in metallo verniciato color scuro.  
Framework - dark painted metal.  
Rahmen - dunkel lackiertes Metallgerüst.

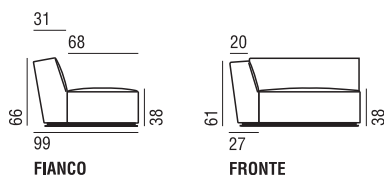

FIANCO

FRONTE

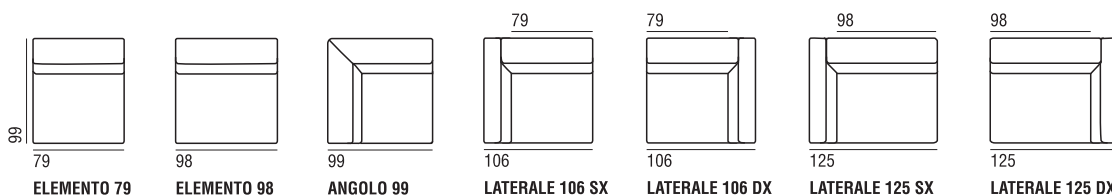

ELEMENTO 79

ELEMENTO 98

ANGOLO 99

LATERALE 106 SX

LATERALE 106 DX

LATERALE 125 SX

LATERALE 125 DX

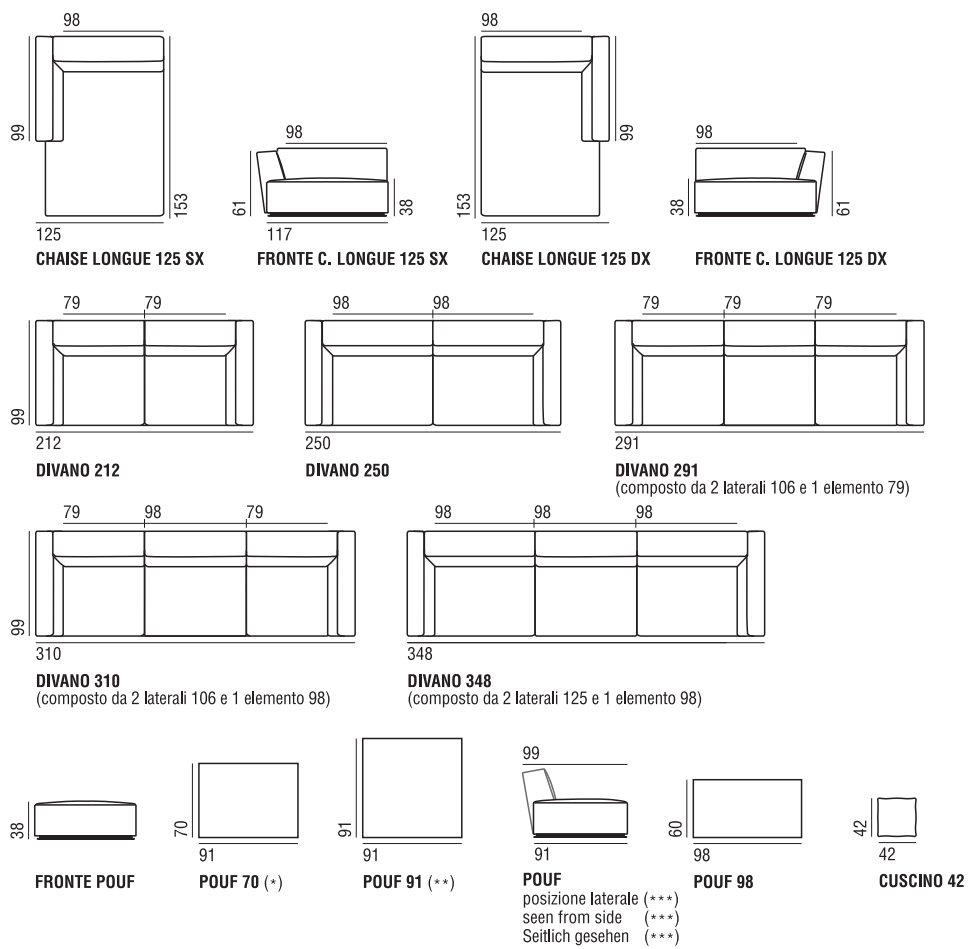

(\*) idoneo per essere posizionato anche lateralmente / ideal in a side position / Kann auch seitlich aufgestellt werden.

(\*\*) idoneo per essere posizionato anche lateralmente o come angolo / ideal in a side or corner position / Kann auch seitlich oder als Eckstück aufgestellt werden.

(\*\*\*) vista del pouf in posizione laterale / view of pouf in side position / Ansicht des Hockers in seitlicher Position.



**Caratteristiche:** Poltrona di design rigoroso, comoda ed adatta alla conversazione, progettata sia per un uso domestico che per un utilizzo contract: receptions, sale d'aspetto, camere d'albergo. E' completamente e facilmente sfoderabile. **Struttura:** Poliuretano schiumato a freddo con inserto in metallo, molleggio con nastri elastici. Prerivestimento con velfodera, piedini in MDF colore nero. **Contract:** Su richiesta, per forniture, si costruisce con materiali ignifughi classe 1IM.

**Features:** Armchair in a simple design, comfortable, and suitable for conversation, designed both to be used in the home and for intense contract use: reception rooms, waiting rooms, hotel rooms. Covers are fully and easily removable. **Framework:** Cold-moulded foamed polyurethane with metal insert, sprung with elastic bands. Under-covering in Velfodera lining, feet in MDF black colouring. **Contract:** on request it can be carried out with fire-resistant materials class 1IM for contract supplies.

**Eigenschaften:** Sessel in rigorosem Design, bequem und zur Konversation geeignet, sowohl für den häuslichen als auch für den Objektbereich entwickelt Rezeptionen, Warteräume, Hotelzimmer. Komplett und einfach abziehbar. **Struktur:** Kaltgeschäumtes Polyurethan mit Metalleinsatz, Federung durch Elastikgurte. Schonbezug aus Velfodera, Füße in MDF Schwarz. **Contract:** Auf Anfrage und für Objektlieferungen kann dieser Sessel mit feuerhemmenden Materialien Klasse 1IM geliefert werden.

#### PIEDE FOOT FUß

MDF verniciato color nero.  
MDF black varnished.  
MDF schwarz lackiert.

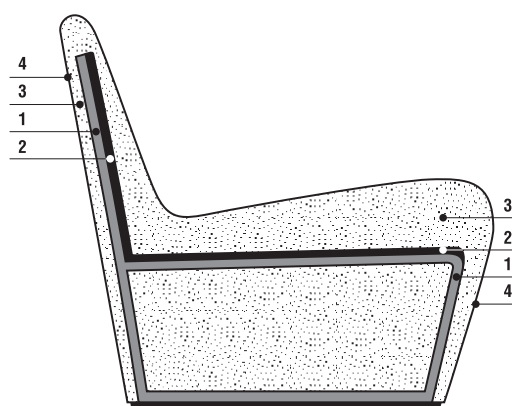

#### SEZIONE SECTION SEKTION

- 1: Telaio in metallo. Metal frame.  
Grundgestell aus Metall.
- 2: Nastri elastici. Elastic belts.  
Elastische Gurte.
- 3: Poliuretano schiumato a freddo.  
Cold-molded foamed polyurethane.  
Kaltgeschäumtes Polyurethan.
- 4: Velfodera. Velfodera. Velfodera.

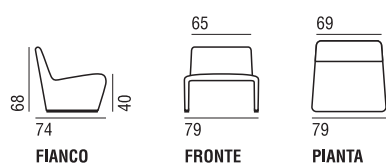



**Caratteristiche:** Rubik si distingue per la sua linea rigorosa, compatta, essenziale ed elegante; offre un'ampia gamma di divani, di elementi laterali e angolari per un totale di 37 moduli con diverse funzioni, i quali, liberamente abbinati, sono in grado di assicurare innumerevoli combinazioni. In particolare si può ottenere l'angolo in ogni elemento fornito di bracciolo; nel caso dei divani con due braccioli, uno dei braccioli può svolgere la funzione di angolo e l'altro bracciolo la funzione di laterale. I guanciali-schienali che corredano i vari elementi sono consigliati per avere un buon livello di comfort; il loro numero è da stabilire in virtù dell'uso e dell'immagine che si intende dare al divano. A listino è quindi indicato il prezzo del divano "base" a cui vanno sommati i guanciali-schienali scelti. Per praticità, a listino, indichiamo la quantità (min. e max.) di guanciali-schienali che riteniamo più idonea per ogni modulo della collezione. Il rivestimento è completamente sfoderabile. **Struttura:** Braccioli, schienali e sedili sono componenti indipendenti che vengono fissati ad una struttura metallica verniciata che fa da base e da supporto; questo consente di smontare e rimontare in modo semplice e rapido i vari componenti, facilitandone la sfoderabilità e il trasporto. Braccioli, schienali e sedili hanno una struttura in legno multistrato e massello. **Imbottiture:** Braccioli, schienali e sedili sono imbottiti in poliuretano a densità differenziata e rivestiti in fibra poliestere accoppiata con tela di cotone. I guanciali sono in piuma d'oca e anitra bianca vergine.

**Characteristics:** Rubik distinguishes itself thanks to its rigorous, compact, essential and elegant lines. It has a wide range of modular sofas, corner and lateral elements for a total of 37 modular units with different functions, which, freely combined, allow countless combinations to be obtained. In particular, any element with an armrest can be turned into a corner element; in the case of sofas with two armrests, one of the armrests can function as a corner element while the other armrest can act as a lateral element. The cushions backrests that accompany the different elements are recommended for comfort; their number should be established with an eye to the intended use and the image the sofa should portray. The price list indicates the price of the basic sofa to which the chosen cushions backrests should be added. For practical purposes, the (minimum and maximum) quantities we deem suitable for each module of the collection are indicated in the price list. The cover is completely removable. **Framework:** Armrests, backrests and seats are independent elements fixed to a varnished metal structure that acts as a base and support; this allows the different components to be taken apart and reassembled simply and rapidly, making the removal of covers and transport easier. Armrests, backrests and seats have a multi-layered wood and solid wood structure. **Padding:** Armrests, backrests and seats are padded with differentiated density polyurethane and covered in polyester fiber coupled with cotton cloth. The pillows are filled with new goose and white duck down.

**Eigenschaften:** Rubik ist durch geometrische, kompakte, essentielle, elegante Linien gekennzeichnet. Die Kollektion bietet eine große Auswahl an Sofas, Eck- und Seitenelementen - insgesamt 37 Elemente, die verschiedene Funktionen haben und untereinander kombiniert werden können, um unendliche Zusammenstellungen zu schaffen. Jedes Element mit Armlehne kann sowohl als Eck- als auch als Seitenelement eingesetzt werden. Die auf Anfrage erhältlichen Wurfkissen (cm. 57x57), mit denen die verschiedenen Elemente ausgestattet werden können, werden für einen maximalen Komfort empfohlen; ihre Anzahl hängt davon ab, wie das Sofa benutzt wird und welches Aussehen man dem Sofa geben will. In der Preisliste wird deswegen der Basispreis des Sofas angegeben, dem der Preis der ausgewählten Wurfkissen addiert werden muss. In der Preisliste wird die empfohlene Anzahl (mind. und max.) an Wurfkissen angegeben. Der Bezug ist komplett abziehbar. **Struktur:** Armlehnen, Rückenlehnen und Sitzflächen sind voneinander unabhängige Elemente, die an einem lackiertem Metallgestell, das als Basis und Träger gilt, befestigt sind. Diese Unabhängigkeit ermöglicht eine mühelose Demontage und Montage der verschiedenen Bestandteile, was wiederum die Abziehbarkeit und den Transport erleichtert. Armlehnen, Rückenlehnen und Sitzflächen haben eine Struktur aus Mehrschicht- und Massivholz. **Kissenpolsterung:** Armlehnen, Rückenlehnen und Sitzflächen haben eine Polsterung aus Polyurethan in unterschiedlicher Dichte und einen Schonbezug aus Polyester und Baumwolle. Die Kissen sind aus reinen Gans- und weißen Entenfedern.

#### BASE BASE UNTERBAU

Metallo verniciato color nero.  
Black painted metal.  
Schwarz lackiertes Metallgerüst.



#### SEZIONE SECTION SEKTION

- 1: Fibra Poliestere. Polyester Fibre. Polyesterfaser.
- 2: Poliuretano a densità differenziata.  
Schwarz lackiertes Metallgerüst. Differentiated density polyurethane.  
Polyurethan unterschiedlicher Dichte.
- 3: Fusto in legno massello e multistrato.  
Frame in solid wood and plywood. Korpus aus Massiv- und schichtverleimtem Holz.
- 4: Fodera in tela. Fabric lining. Schonbezug.
- 5: Piuma. Down. Federfüllung.
- 6: Base - supporto in metallo verniciato color nero.  
Framework - black painted metal.  
Rahmen - schwarz lackiertes Metallgerüst.
- 7: Fodera in tessuto antipiuma.  
Featherproof fabric cover.  
Federnundurchlässiger Bezug.

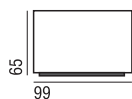
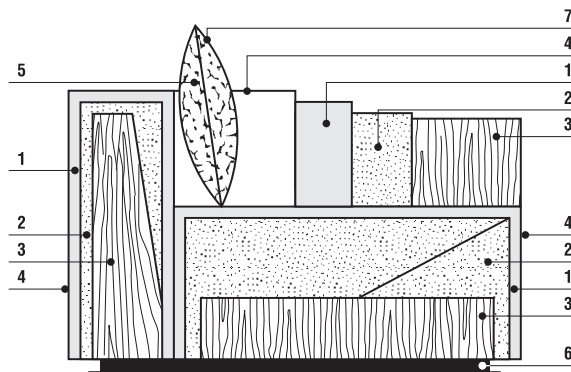

FIANCO

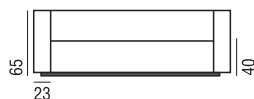

FRONTE

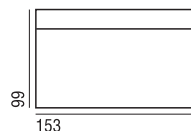

ELEMENTO 153

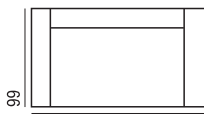

DIVANO 176

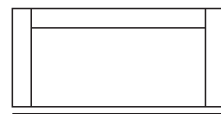

DIVANO 198

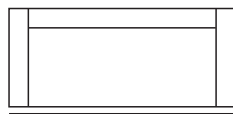

DIVANO 220

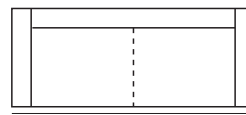

DIVANO 242  
cuscino unico / cuscini divisi

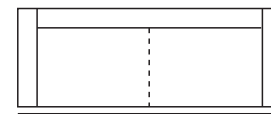

DIVANO 264  
cuscino unico / cuscini divisi

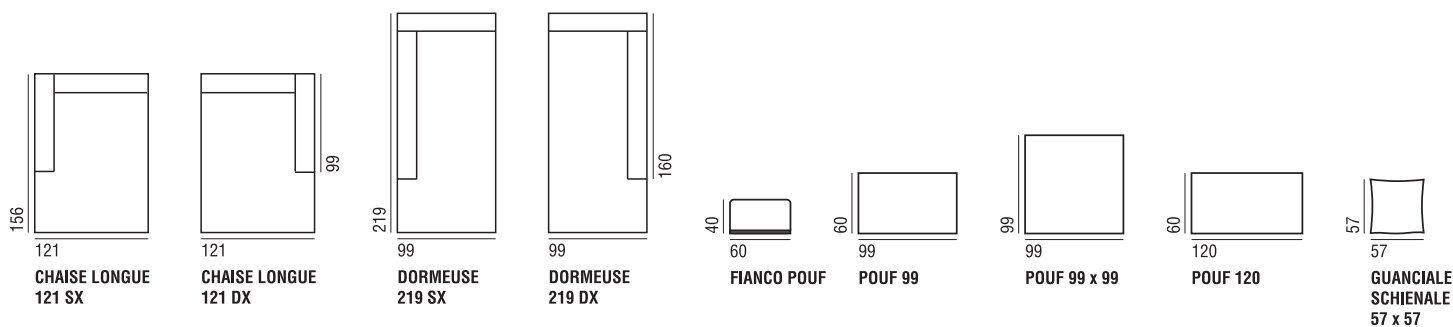
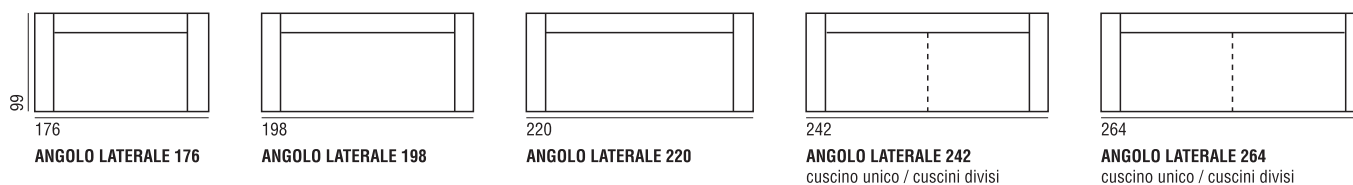
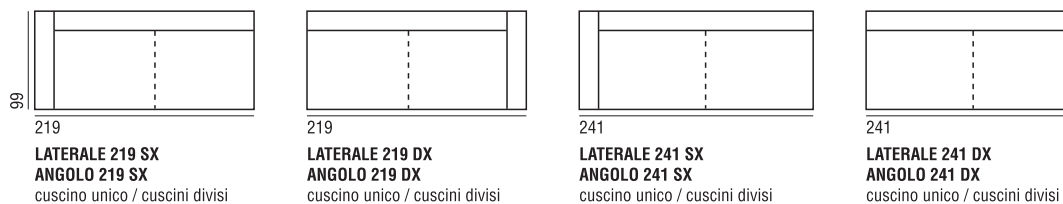
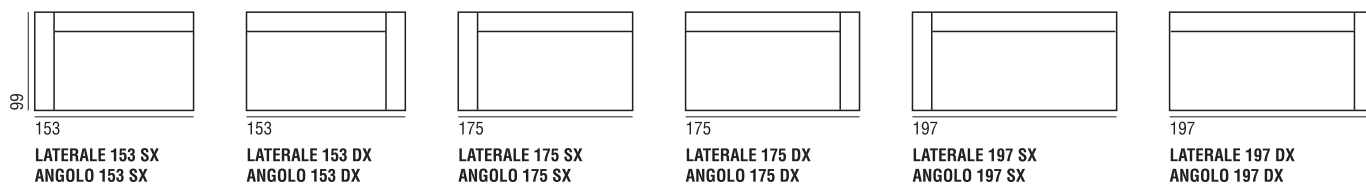



**Caratteristiche:** Poltrona girevole fornita sia in versione alta, con poggiatesta regolabile a varie altezze, che in versione bassa. La versione alta consente di raggiungere il massimo comfort soprattutto se abbinata al pouf sempre girevole. La versione bassa è adatta alla conversazione. Ambedue sono progettate anche per un uso di contract intenso. Sono completamente e facilmente sfoderabili. **Struttura:** Fusto in legno multistrato, imbottito in poliuretano ad altissima densità e a quote differenziate; molleggio con nastri elastici intrecciati. Prerivestimento con tela accoppiata con fibra poliestere. La base è a 4 razze girevole a 360° in fusione di alluminio e disponibile nelle seguenti finiture: lucidata, verniciata a polvere colore bianco opaco (RAL 9003) oppure colore antracite micaceo. **Imbottiture cuscini:** I cuscini di seduta sono in poliuretano indeformabile più fibra poliestere. **Contract:** Su richiesta, per forniture, si costruisce con materiali ignifughi classe 1 IM.

**Features:** Swivel armchair with high version, with headrest adjustable in different heights, or with low version. The high version reaches maximum comfort especially if used together with the pouf, which is swivel as well. The low model is suitable for sitting and chatting. Both armchairs are designed also for contract use and covers are completely and easily removable. **Structure:** The frame is made of plywood and padded with very high density differentiated polyurethane; the armchair is sprung with interwoven elastic belts. The lining consists of fabric coupled with polyester fibre. Sillon is provided with a 360° swivel trestle with four-legged support structure in aluminium cast available with following finishes: polished, with powder in white matt (RAL 9003) or in dark grey micaceous painted. **Cushion padding:** The seat cushions are made of non-deformable polyurethane plus polyester fibre. **Contract:** For large quantities available upon request made using fireproof materials belonging to Class 1 IM.

**Eigenschaften:** Drehbarer Sessel, lieferbar in Variante "Sillon Alto", d.h. mit höhenverstellbarer Kopfstütze und in Variante "Sillon Basso" d.h. ohne Kopfstütze. Die Ausführung "Alto" ermöglicht ein Höchstmaß an Komfort, besonders in Zusammenhang mit dem drehbaren Hocker. Die Ausführung "Basso" ist zur Konversation geeignet. Beide sind auch für den Objektbereich entwickelt und einfach und komplett abziehbar. **Struktur:** Korpus aus schichtverleimtem Holz, gepolstert mit hochdichtem und schichtdifferenziertem Polyurethan, Federung mit geflochtenen elastischen Gurten. Schonbezug aus Stoff, gepaart mit Polyesterfaser. Der Sessel hat ein vierbeiniges, 360° drehbares Untergestell in Aluminiumguss und alternativ folgende Ausführungen: poliert, Pulverbeschichtung in Mattweiß, matt (RAL 9003) oder in Anthrazit Glimmerlack. **Kissenpolsterung:** Die Sitzkissen sind aus formstabilem Polyurethan plus Polyesterfaser. **Objektbereich:** Auf Anfrage, kann Sillon mit feuerfesten Materialien der Klasse 1 IM geliefert werden.

#### BASE BASE UNTERBAU

- |                                |  |
|--------------------------------|--|
| 4 razze:                       | - Fusione alluminio lucidato             |
| Poltrona Girevole 360°         | - Fusione alluminio verniciato bianco    |
|                                | - Fusione alluminio verniciato antracite |
| Four-legged support structure: | - polished aluminium cast                |
| Armchair, 360° swivel          | - painted aluminium cast - white         |
|                                | - painted aluminium cast - dark grey     |
| 4 Füße:                        | - polierter Aluminiumguss                |
| Sessel, um 360° drehbar        | - lackierter Aluminiumguss, Weiß         |
|                                | - lackierter Aluminiumguss, Anthrazit    |

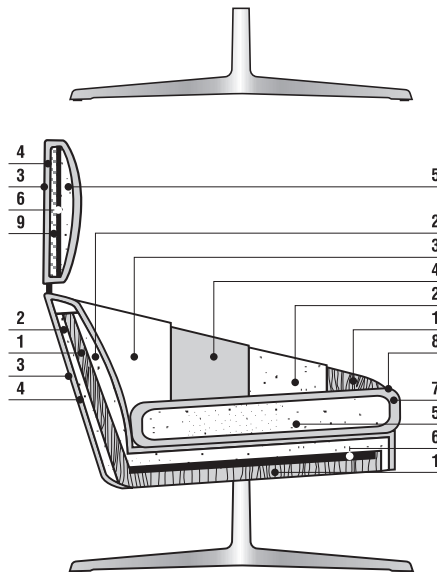
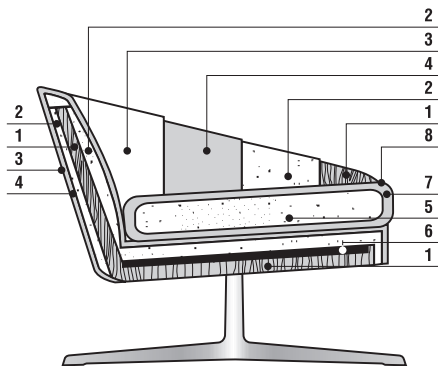

#### SEZIONE SECTION SEKTION

- 1: Fusto in multistrato. Frame in plywood.  
Rumpf schichtverleimt.
- 2: Poliuretano alta densità.  
High-Density polyurethane.  
Hochdichtes Polyurethan.
- 3: Fodera in tela. Fabric lining. Stoff-Futter.
- 4: Fibra Poliestere. Polyester Fibre.  
Polyesterfaser.
- 5: Poliuretano indeformabile.  
Non-deformable polyurethane.  
Undeformierbares Polyurethan.
- 6: Nastri elastici. Elastic belts. Elastische Gurte.
- 7: Fibra Poliestere Dacron® DuPont.  
Polyester Fibre Dacron® DuPont.  
Polyesterfaser von Dacron® DuPont.
- 8: Velfodera. Velfodera. Velfodera.
- 9: Telaio in metallo. Metal frame.  
Metallrahmen.

#### SILLÓN BASSA



#### SILLÓN ALTA

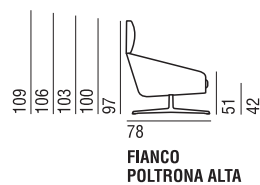

#### POUF

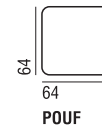
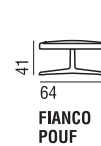

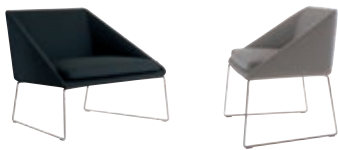

**Caratteristiche:** Collezione composta dalla poltrona, adatta alla conversazione, progettata sia per un uso domestico che per un utilizzo contract: receptions, sale d'aspetto, camere d'albergo, e dalla sedia, adatta per tavolo da pranzo o tavolo riunione. Ambedue comode ed ergonomicamente corrette sono completamente e facilmente sfoderabili. **Struttura:** Poliuretano schiumato a freddo con inserto in metallo, molleggio con nastri elastici. Prerivestimento con velfodera, base in metallo cromato. **Contract:** Poliuretano schiumato a freddo con inserto in metallo, molleggio con nastri elastici. Prerivestimento con velfodera, base in metallo cromato.

**Features:** The collection consists of an armchair, suitable for conversation, designed both to be used in the home and for intense contract use: reception rooms, waiting rooms, hotel rooms, and a chair for the dining table or meeting table. Both are comfortable and ergonomically correct. Covers are fully and easily removable. **Structure:** Cold-moulded foamed polyurethane with metal insert, sprung with elastic bands. Under-covering in Velfodera lining, frame of metal with chrome finishing. **Contract:** Available upon request, made using fireproof materials belonging to Class 1 IM.

**Eigenschaften:** Die Kollektion besteht aus einem bequemen und große Ruhe ausstrahlenden Sessel, der sich sowohl für den privaten Gebrauch wie auch für den Objektbereich eignet, wie z.B für Empfangs- und Warteräume oder Hotelzimmer. Der dazu passende Stuhl, ergonomisch perfekt wie der Sessel, findet seinen Einsatz im Ess- und Besprechungsbereich. Das Highlight beider Teile ist die einfache, komplette Abziehbarkeit. **Struktur:** Kaltgeschäumtes Polyurethan mit Metalleinsatz, Federung durch Elastikgurte. Schonbezug aus Velfodera. Verchromtes Metallgestell. **Contract:** Für den Einsatz im Objektbereich ist auf Anfrage die Verwendung von feuerhemmenden Materialien Klasse 1IM möglich.

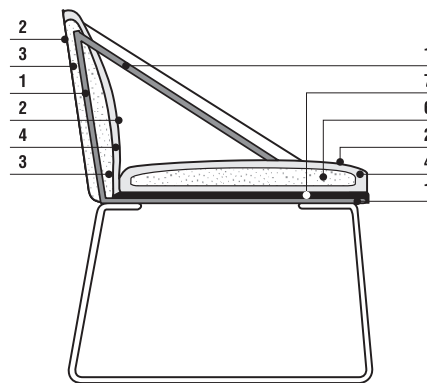
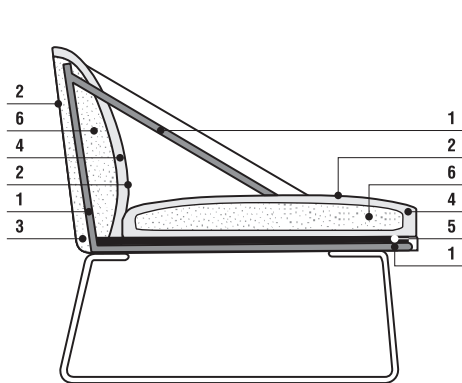

#### SEZIONE SECTION SEKTION

- 1: Telaio in metallo. Metal frame.  
Grundgestell aus metall.
- 2: Velfodera. Velfodera. Velfodera.
- 3: Poliuretano schiumato a freddo.  
Cold-molded foamed polyurethane.  
Kaltgeschäumtes Polyurethan.
- 4: Fibra Poliestere. Polyester Fibre.  
Polyesterfaser.
- 5: Nastri elastici. Elastic belts. Elastische Gurte.
- 6: Poliuretano. Polyurethane. Polyurethan.
- 7: Pannello multistrato. Plywood panel.  
Schichtverleimte Holzplatte.

#### KELLY POLTRONA

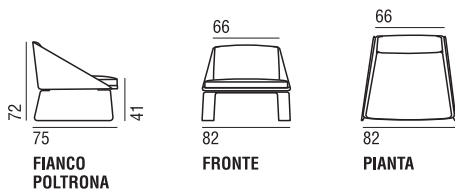

#### KELLY SEDIA

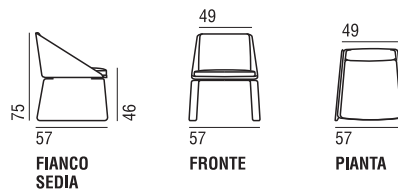





**Caratteristiche:** Collezione composta dalla poltrona, adatta alla conversazione e dalla sedia adatta per il tavolo da pranzo o il tavolo da riunione. Ambedue comode ed ergonomicamente corrette, sono state progettate anche per un uso di contract intenso. Sono completamente e facilmente sfoderabili ad esclusione della versione in pelle. **Struttura:** Fusto in legno multistrato, imbottito in poliuretano ad altissima densità e a quote differenziate; la poltrona ha il molleggio con nastri elastici intrecciati. Prerivestimento con tela accoppiata con fibra poliestere. La poltrona si fornisce con base a 4 razze girevole a 360° in fusione di alluminio nelle seguenti finiture: lucidata, verniciata a polvere colore bianco opaco (RAL 9003) oppure colore antracite micaceo o con base a quattro gambe in metallo, finitura color alluminio; la sedia si fornisce con la base a quattro razze girevole a 180° con ritorno automatico sempre in metallo, finitura color alluminio. **Imbottiture cuscini:** I cuscini di seduta sono in poliuretano indeformabile più fibra poliestere. **Contract:** Su richiesta, per forniture, si costruisce con materiali ignifughi classe 1 IM.

**Features:** The collection consists of an armchair for sitting and chatting and a chair for the dining table or meeting table. Both chairs are comfortable and ergonomically correct and are also designed for contract use; covers are completely and easily removable. **Structure:** The frame is made of plywood and padded with very high density differentiated polyurethane; the armchair is sprung with interwoven elastic belts. The lining consists of fabric coupled with polyester fibre. The armchair is supplied with a 360° swivel 4 legged support structure in aluminium cast in the following finishes: polished, in matt white (RAL 9003) or in dark grey micaceous painted or with a fixed four-legged support in metal with, aluminium-look finish; the chair is supplied with a 180° swivel 4 legged support structure with automatic return, always in metal, with aluminium-look finish. **Cushion padding:** Seat cushions are made of non-deformable polyurethane plus polyester fibre. **Contract:** For large quantities available upon request made using fireproof materials belonging to Class 1 IM.

**Eigenschaften:** Kollektion bestehend aus einem Konversationsessel und aus einem Stuhl, passend sowohl an einen Ess- als auch an einen Konferenztisch. Beide bequem und ergonomisch korrekt, wurden diese Sitzmöbel auch für den Objektbereich entwickelt. Beide Artikel sind komplett und einfach abziehbar, mit Ausnahme der Lederausführung. **Struktur:** Korpus aus Mehrschichtholz, mit hochdichtem, schichtdifferenziertem Polyurethan. Der Sessel hat eine Federung mit elastischen, geflochtenen Gurten. Schonbezug aus Stoff, gepaart mit Polyesterfaser. Der Sessel wird mit 360° drehbarem, vierbeinigem Untergestell aus Aluminiumguss in den folgenden Ausführungen geliefert: poliert, Matt Weiß pulverbeschichtet (RAL 9003) oder glimmerig-anthrazit oder mit vier aluminiumfarbigen Metallfüßen. Der Stuhl wird mit einem, um 180° drehbaren vierbeinigem Untergestell mit automatischer Rückstellung geliefert, immer in aluminiumfarbigem Metall. **Kissenpolsterung:** Sitzkissen aus formstabilem Polyurethan mit Polyesterfaser. **Objektbereich:** Auf Anfrage, kann Cubica für größere Mengen mit feuerfesten Materialien der Klasse 1 IM geliefert werden.

**BASE BASE UNTERBAU**

4 razze: - Sedia, girevole a 180°

Four-legged support structure: - Chair, 180° swivel

4 Füße: - Stuhl, um 180° drehbar

4 razze: Poltrona Girevole 360°

Four-legged support structure: - polished aluminium cast  
- painted aluminium cast - white  
- painted aluminium cast - dark grey

4 Füße: Sessel, um 360° drehbar  
- polierter Aluminiumguss  
- lackierter Aluminiumguss, Weiß  
- lackierter Aluminiumguss, Anthrazit

4 gambe: - Poltrona  
4 legs: - Armchair  
4 Füße: - Sessel

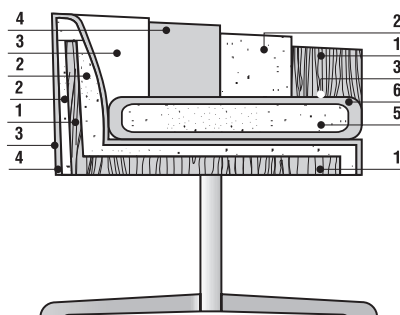
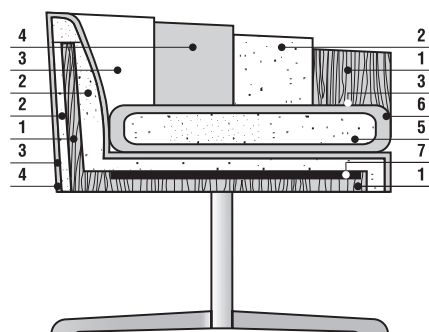
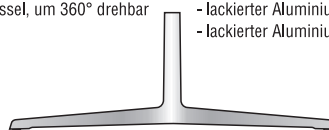
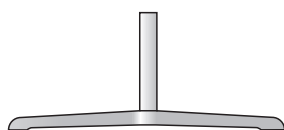

**SEZIONE SECTION SEKTION**

- 1: Fusto in multistrato. Frame in plywood. Korpus schichtverleimt.
- 2: Poliuretano alta densità a quota differenziata. High density differentiated polyurethane. Hochdichtes Polyurethan mit unterschiedlicher Dichte.
- 3: Fodera in tela. Fabric lining. Schonbezug.
- 4: Fibra Poliestere. Polyester Fibre. Polyesterfaser.
- 5: Poliuretano indeformabile. Non-deformable polyurethane. Formstabiles Polyurethan.
- 6: Fibra Poliestere. Polyester Fibre. Polyesterfaser.
- 7: Nastri elastici. Elastic belts. Elastische Gurte.

**CUBICA POLTRONA**

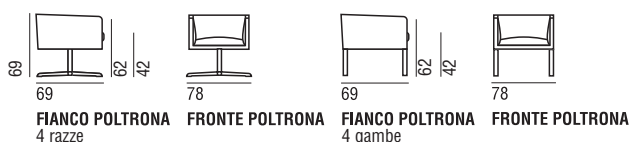

**CUBICA SEDIA**

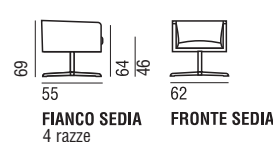



**Caratteristiche:** Linea essenziale. Offre un'elevata comodità nonostante le dimensioni ridotte. La collezione nella versione a schienale alto è composta da poltrona e pouf poggiapiedi. Nella versione a schienale basso è composta da poltrona, divano 2 posti, divano 3 posti e pouf poggiapiedi. Il rivestimento è completamente sfoderabile. **Struttura:** Fusto in multistrato curvato e legno massello. Imbottito in poliuretano indeformabile a densità differenziata, molleggio con nastri elastici intrecciati. Prerivestimento con Velfodera bianca accoppiata con poliuretano. I piedi sono in faggio tinto ciliegio o tinto wengé. **Imbottiture cuscini:** Cuscino in poliuretano espanso indeformabile ad alta densità più fibra poliestere.

**Features:** Essential line. It offers a high level of comfort despite the reduced dimensions. The high-backrest version collection comprises armchair and a footrest pouf. The low-backrest version comprises armchair, 2-seater settee, 3-seater settee, and a footrest pouf. The cover is completely removable. **Structure:** Frame in curved plywood and solid wood. Padded with non - deformable differentiated density polyurethane, sprung with interwoven elastic belts. Lining with white Velfodera coupled with polyurethane. Beechwood feet stained cherry or wengé. **Cushion padding:** Seat cushion in non - deformable high density expanded polyurethane plus polyester fibre.

**Eigenschaften:** Einfache Linie, trotz der geringen Abmessungen optimale Bequemlichkeit. Die Kollektion in der Ausführung mit hoher Rückenlehne besteht aus Sessel und Hocker als Fußstütze. Die Kollektion in der Ausführung mit niedriger Rückenlehne besteht aus Sessel, 2-Sitzer Sofa, 3-Sitzer Sofa und Hocker als Fußstütze. Der Bezug ist komplett abziehbar. **Struktur:** Schichtverleimtes, gebogenes Holz und Massivholz. Polsterung aus formstabilem Polyurethan unterschiedlicher Dichte, Federung aus kreuzartig angeordneten elastischen Bändern. Schonbezug ( Velfodera ) aus weißem Futterstoff mit Polyurethan. Füße aus Buchenholz gebeizt in Kirsch-oder Wengefarben. **Kissenpolsterung:** Gefüllt mit formstabilem hochdichten Polyätherschaum und Polyesterfaser.

#### PIEDE FOOT FUß

Faggio tinto wengé o tinto ciliegio.  
Beechwood stained wengé or cherry.  
Buche, kirschholzfarben oder wengeholzgebeizt.

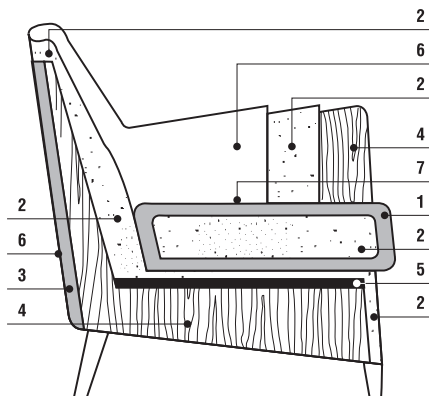
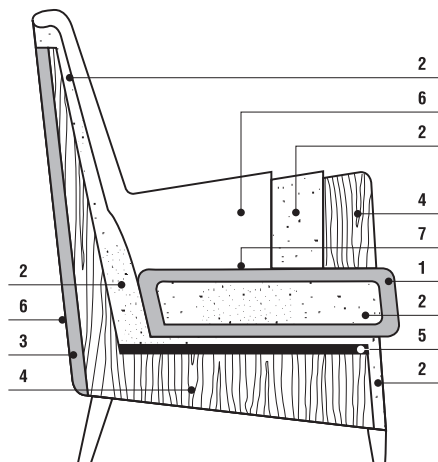
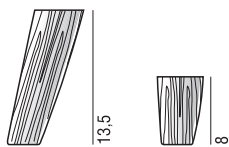

#### SEZIONE SECTION SEKTION

- 1: Fibra poliestere. Polyester Fibre. Polyesterfaser.
- 2: Poliuretano. Polyurethane. Polyurethan.
- 3: Fibra poliestere. Polyester Fibre. Polyesterfaser.
- 4: Fusto in legno massello e multistrato curvato.  
Frame in solid wood and curved plywood.  
Korpus aus Massivholz, oder schichtverleimt und gewölbt.
- 5: Nastri elastici. Elastic belts. Elastische Gurte.
- 6: Velfodera. Velfodera. Velfodera.
- 7: Fodera in tela. Fabric lining. Schonbezug.

#### CALVINO SCHIENALE ALTO

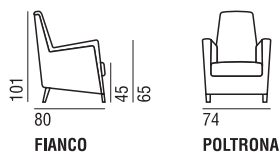

#### CALVINO SCHIENALE BASSO

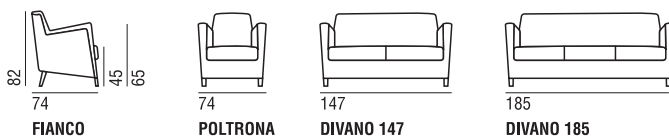

#### POUF

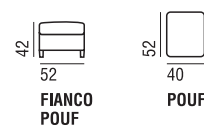



**Caratteristiche:** Collezione di tavolini disponibili in due misure di diametro e tre altezze accostabili e sovrapponibili. **Struttura e finiture:** Piano noce massello finitura olio naturale spessore 30 mm. Base in pressofusione di alluminio verniciato colore bronzo.

**Features:** Coffee tables available in two diameters and in three different, approachable and overlapping heights. **Structure and finish:** Top in solid walnut natural oil finish, thickness 30 mm. Base in bronze painted die-cast aluminium.

**Eigenschaften:** Beistelltische in zwei unterschiedlichen Durchmesser und drei Höhen, kombinier- und überlappend aufstellbar. **Struktur und Ausführung:** Massive Nussbaumplatte mit Naturöl-Finish 30 mm stark. Untergestell aus Aluminiumdruckguss, bronzefarben lackiert.



**ROBIN TAVOLINO Ø 60**



**ROBIN TAVOLINO Ø 70**

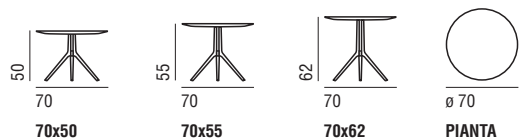



**Caratteristiche:** I pouf dalla forma circolare Planet sono disponibili nelle dimensioni di cm.90 e cm.110. Abbinabili ai tavoli bassi Antero, rappresentano un valido satellite a completamento della composizione principale. Grazie al design essenziale, sono adatti sia agli ambienti residenziali che a quelli pubblici come ad esempio le lounges degli alberghi o le sale d'attesa. I pouf Planet rappresentano delle comode sedute e dei validi piani di appoggio. **Struttura:** Struttura in legno multistrato, imbottitura interamente in poliuretano ad alta densità. Prerivestimento con velfodera accoppiata con fibra poliesteri. Il rivestimento, ad eccezione della versione in pelle, è completamente sfoderabile. Piedini in MDF verniciato di colore nero. **Contract:** Su richiesta, per forniture, si costruisce con materiali ignifughi.

**Features:** Collection Planet consists in round poufs available in two sizes: 90 and 110 cm. Combined with the coffee tables Antero Planet represents a valid satellite to complete the main composition. Thanks to its essential design it is suitable to be used both for residential as well as public areas, such as hotel lounges or waiting rooms. Planet offers a comfortable seat and can be used as a valid support surface. **Framework:** Frame in plywood padded with high density polyurethane. Lining in Velfodera coupled with polyester fibre. Cover can be completely removed except for the leather version. Feet are in black painted MDF. **Contract:** Available with fire resistant materials upon request.

**Eigenschaften:** Die runden Hocker Planet sind in den Größen 90 cm oder 110 cm lieferbar. Kombiniert mit dem Couchtisch Antero, sind sie ein nützlicher Satellit zur Vervollständigung der Hauptkomposition. Dank ihres essentiellen Designs eignen sie sich sowohl für Wohnbereiche als auch für öffentliche Bereiche wie Hotellounges oder Wartezimmer. Planet Hocker dienen als bequeme Sitz- und nützliche Auflageflächen. **Struktur:** Korpus in Mehrschichtholz, Polsterung ganz in Polyurethan hoher Dichte. Unterbezug in Velfodera gekoppelt mit Polyesterfaser. Der Bezug, mit Ausnahme von Leder, ist komplett abziehbar. Füße in MDF schwarz lackiert. **Projekt:** Auf Anfrage und für Objektlieferungen können die Hocker mit feuerhemmenden Materialien geliefert werden.

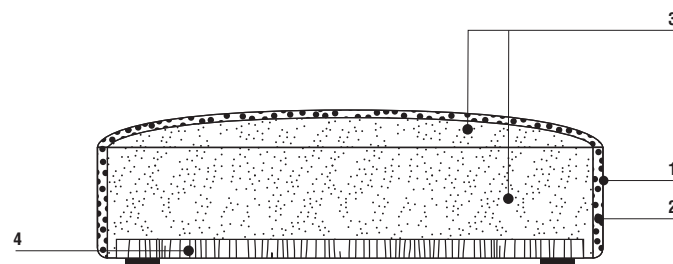

#### SEZIONE SECTION SEKTION

- 1: Velfodera. Velfodera. Velfodera.
- 2: Fibra poliesteri. Polyester Fibre  
Polyesterfaser.
- 3: Poliuretano a densità differenziata.  
Differentiated density polyurethane.  
Polyurethan unterschiedlicher Dichte.
- 4: Fusto in legno multistrato.  
Frame in plywood.  
Korpus in Schichtholz.

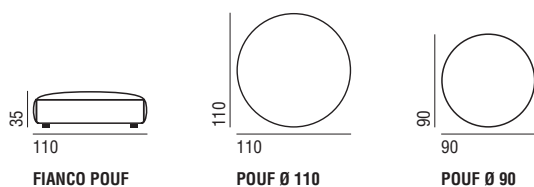



**Caratteristiche:** Tavolino dal design lineare e funzionale con piano in marmo; disponibile rotondo o quadrato. Adatto ad ambienti residenziali così come ad aree lounge e raffinati progetti contract. **Struttura:** Piano in marmo Nero Marquina o Emperador, spessore mm 20. Il marmo è un prodotto naturale, che presenta di volta in volta venature, concentrazioni di colore e macchie chiaro scure sempre diverse. La superficie può presentarsi irregolare e in alcuni punti può risultare più o meno lucida, queste sono caratteristiche che determinano la naturalità del marmo stesso, quindi queste imperfezioni devono essere accettate in quanto caratteristiche inevitabili e naturali di questi materiali. Specialmente il marmo Emperador e il marmo Nero Marquina presentano normalmente e per loro struttura numerose fessure, microfessure, fori e micro fori. Quelli più evidenti vengono resinati, stuccati, ricostruiti. Questo non pregiudica la qualità o la tenuta strutturale del prodotto. Base in pressofusione di alluminio verniciata color bronzo.

**Features:** Coffee table with a linear and functional design with marble top; available round or square. Suitable for residential environments as well as for lounge areas and refined contract projects. **Structure:** Top in Nero Marquina or Emperador marble, 20 mm thick. Marble is a natural material showing veins, concentrations of colour as well as light and dark spots which are different every time. The surface may appear uneven and in some places it may be more or less shiny, these are characteristics that determine the naturalness of the marble itself, therefore these imperfections must be accepted as inevitable and natural characteristics of these materials. Emperador and Nero Marquina marbles show in their natural form numerous cracks, micro-cracks, holes and micro holes. The most evident ones are sealed, plastered or rebuilt, but this does not affect the quality or structural strength of the product. Base in die-cast aluminum painted in bronze color.

**Eigenschaften:** Couchtisch mit einem linearen und funktionellen Design mit Marmorplatte; verfügbar in rund oder quadratisch. Geeignet sowohl für Wohn- als auch für Lounge Bereiche und raffinierte Vertragsprojekte. **Struktur:** Tischplatte aus Marmor Nero Marquina oder Emperador, 20 mm stark. Marmor ist ein Naturprodukt, das abwechselnd Äderungen, unterschiedliche Farbkonzentrationen sowie helle und dunkle Flecken zeigt. Die Oberfläche kann uneben und an einigen Stellen mehr oder weniger glänzend sein. Dies sind Eigenschaften, die die Natürlichkeit des Marmors bestimmen. Diese Makel sind zu akzeptieren, da unvermeidliche und natürliche Eigenschaften dieses Materials. Insbesondere der Marmor Emperador und der Nero Marquina weisen normalerweise zahlreiche Risse, Mikrorisse, kleine Löcher auf. Die am sichtbarsten werden verharzt, verputzt und rekonstruiert. Dies beeinträchtigt in keiner Weise die Qualität oder strukturelle Stabilität des Produkts. Untergestell aus Aluminiumdruckguss, bronzenfarben lackiert.



**STRUTTURA STRUCTURE STRUKTUR**

**1:** Pressofusione di alluminio verniciato color bronzo  
Die-cast aluminum painted bronze  
Aluminiumdruckguss in Bronzefarbe

ANTERO TAVOLINO Ø 115

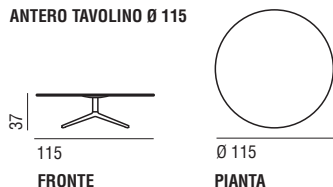

ANTERO TAVOLINO 110x110

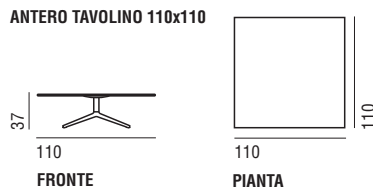



**Caratteristiche:** Con la sua leggerezza Etan sa conquistare chi desidera completare con grazia i propri spazi. Le sue linee verticali, una opposta all'altra, creano un gioco visivo che mostra il carattere distintivo della libreria. È stata disegnata con una dolce raggittura che le conferisce un aspetto accogliente e friendly. Disponibile in due diverse altezze, accostabili liberamente fra loro, consente di organizzare lo spazio a disposizione, secondo le proprie necessità, in modo semplice ed efficace. **Struttura e Finitura:** Particolare attenzione è stata portata dal progettista allo studio del montaggio, per essere veramente semplice e alla portata di tutti, anche ai meno esperti. L'ingegnerizzazione di Etan non ha trascurato nemmeno lo studio dell'ingombro, per facilitarne il trasporto. La libreria è realizzata in legno di rovere massello, con finitura a poro aperto, white oil oppure black oil, che ne esalta le naturali venature.

**Features:** With its lightness Etan knows how to conquer those who want to gracefully complete their spaces. Its vertical lines, one opposite to the other, create a visual game that shows the distinctive character of the bookcase. It has been designed with a soft rounding that gives it a welcoming and friendly appearance. Available in two different heights, that can be freely placed together, allowing you to organize the space available, according to your needs, in a simple and effective way. **Structure and Finishing:** Special attention has been paid by the designer to the study of the assembly, to be really simple and user-friendly for everyone, even the less experienced. The engineering of Etan did not neglect even the study of encumbrance, to facilitate transport. The bookcase is made of solid oak wood, with an open-pore finish, white oil or black oil, which enhances its natural grain.

**Eigenschaften:** Etan erobert durch seine Leichtigkeit diejenigen, die ihre Räume mit zierlichen Möbeln ausstatten möchten. Seine vertikalen Linien, eine gegenüber der anderen, schaffen ein visuelles Spiel, das den unverwechselbaren Charakter des Bücherregals zeigt. Die weichen Rundungen verleihen ihm ein ansprechendes und friendly Aussehen. Verfügbar in zwei unterschiedlichen Höhen, können diese beliebig aneinandergestellt werden und somit einfach und wirkungsvoll den verfügbaren Raum, je nach Bedarf, organisieren. **Struktur und Ausführungen:** Besondere Aufmerksamkeit hat der Designer dem Studium der Montage gewidmet, um diese wirklich einfach und für jedermann möglich zu gestalten, auch für weniger Erfahrene. Das Engineering des Etan vernachlässigt nicht einmal das Studium des Platzbedarfs, um den Transport zu erleichtern. Das Bücherregal ist aus Eiche massiv mit offenporigem Finish, white oil oder black oil, die seine natürliche Maserung akzentuieren.

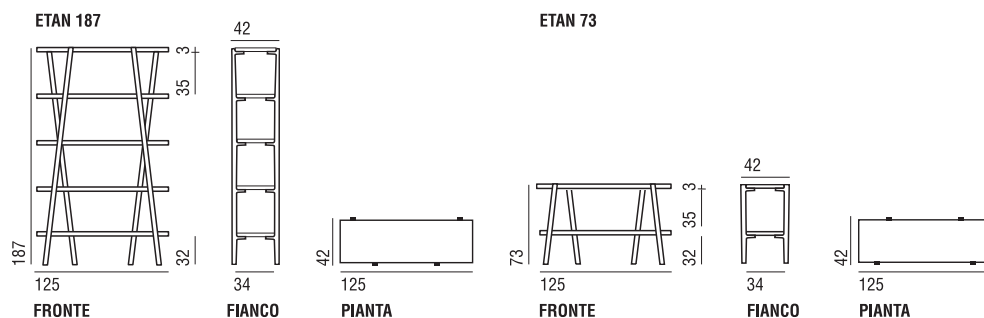

**STRUTTURA STRUCTURE STRUKTUR**

Legno rovere massello, finitura white oil oppure black oil  
 Solid oak white oil or black oil finish  
 Eiche massiv in white oil oder black oil Finish



**Caratteristiche:** Tavolino in legno listellare impiallacciato rovere tinto naturale leggermente sbiancato oppure tinto wengè. Bordo in legno massello stondato. Jim, grazie al particolare disegno della base, è un tavolino idoneo ad essere affiancato ai modelli Joe, Noe, Larsen, Link, Hampton, Hampton Memory, Holden.

**Features:** Laminwood and veneered oak, natural slightly bleached colour, or wengè colour. Round shaped border in solid wood. The particular design of its base makes Jim an ideal match to models Joe, Noe, Larsen, Link, Hampton, Hampton Memory, Holden.

**Eigenschaften:** In Edelholz furniert, Eiche lackiert, gebleicht oder in Farbe Wengè. Einfassung mit gerundetem Massivholz. Dank seines speziellen Designs, ist Jim ein idealer Beistelltisch, passend zu den Modellen Joe, Noe, Larsen, Link, Hampton, Hampton Memory, Holden.

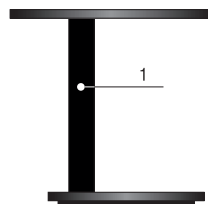

**STRUTTURA STRUCTURE STRUKTUR**

1: Legno listellare impiallacciato.  
Laminwood and veneered oak.  
In Edelholz furniert.

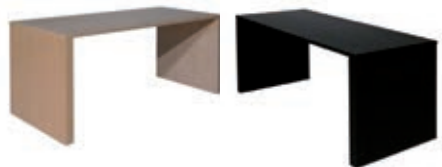

**Caratteristiche:** Tavolino in legno listellare impiallacciato rovere tinto naturale leggermente sbiancato oppure tinto wengè. Bordo in legno massello stondato.

**Features:** Laminwood and veneered oak, natural slightly bleached colour, or wengè colour. Round shaped border in solid wood.

**Eigenschaften:** In Edelholz furniert, in Eiche lackiert, gebleicht oder in Wengé. Einfassung aus gerundetem Massivholz.



**STRUTTURA STRUCTURE STRUKTUR**

1: Legno listellare impiallacciato.  
Laminwood and veneered oak.  
In Edelholz furniert.

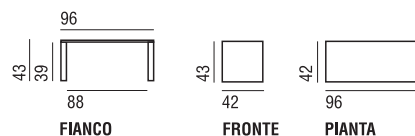



**Caratteristiche:** Serie di tavolini di 3 misure e altezze diverse accostabili e sovrapponibili. **Struttura e finiture:** Struttura e finiture: Piano in laminato stratificato finitura wengé, spessore mm. 12, piano in metallo rivestito in rigenerato di fibre di cuoio color testa di moro, tagliato e cucito al vivo oppure piano in marmo Nero Marquina o Emperador, spessore mm. 20. Il marmo è un prodotto naturale, che presenta di volta in volta venature, concentrazioni di colore e macchie chiaro scure sempre diverse. La superficie può presentarsi irregolare e in alcuni punti può risultare più o meno lucida, queste sono caratteristiche che determinano la naturalità del marmo stesso, quindi queste imperfezioni devono essere accettate in quanto caratteristiche inevitabili e naturali di questi materiali. Specialmente il marmo Emperador e il marmo Nero Marquina presentano normalmente e per loro struttura numerose fessure, microfrazture, fori e micro fori. Quelli più evidenti vengono resinati, stuccati, ricostruiti. Questo non pregiudica la qualità o la tenuta strutturale del prodotto. Base in pressofusione di alluminio verniciata color bronzo. **Customizzazione:** Per progetti e forniture contract, su richiesta, è possibile realizzare i tavolini con il piano con finiture diverse anche in versione ignifugo 1IM. Quotazioni su misura in funzione di finiture e quantità.

**Features:** Series of 3 coffee tables of different sizes and heights matched and overlapping. **Structure and finishes:** Stratified laminate top in wengé finish, thickness 12 mm, top in metal covered by dark brown regenerated leather fibres with visible cut and sewing or top in Nero Marquina or Emperador marble, thickness mm. 20. . Marble is a natural material showing veins, concentrations of colour as well as light and dark spots which are different every time. The surface may appear uneven and in some places it may be more or less shiny, these are characteristics that determine the naturalness of the marble itself, therefore these imperfections must be accepted as inevitable and natural characteristics of these materials. Emperador and NerMarquina marbles show in their natural form numerous cracks, micro-cracks, holes and micro holes. The most evident ones are sealed, plastered or rebuilt, but this does not affect the quality or structural strength of the product. Base in die-cast aluminum painted bronze. **Custom-made:** For projects and contract supplies, on request, we can carry out tables with the top with different finishes even in the 1IM fireproof version. Quotations are made ad hoc up to finishes and quantity required.

**Eigenschaften:** Serie von 3 Beistelltischen verschiedener Größen und Höhen, aufeinander abgestimmt und überlappend aufstellbar. **Struktur und Ausführungen:** Top in Schichtlaminat in Farbe Wengé, Stärke 12 mm; Metalltop mit dunkelbraunem Bonded Leder mit Steppnaht oder Marmortop in Nero Marquina oder Emperador, Stärke 20 mm. Marmor ist ein Naturprodukt, das abwechselnd Äderungen, unterschiedliche Farbkonzentrationen sowie helle und dunkle Flecken zeigt. Die Oberfläche kann uneben und an einigen Stellen mehr oder weniger glänzend sein. Dies sind Eigenschaften, die die Natürlichkeit des Marmors bestimmen. Diese Makel sind zu akzeptieren, da unvermeidliche und natürliche Eigenschaften dieses Materials. Insbesondere der Marmor Emperador und der Nero Marquina weisen normalerweise zahlreiche Risse, Mikrorisse, kleine Löcher auf. Die am sichtbarsten werden verharzt, verputzt und rekonstruiert. Dies beeinträchtigt in keiner Weise die Qualität oder strukturelle Stabilität des Produkts. Untergestell in Aluminium-Druckguss in Bronzefarbe. **Sonderanfertigungen:** Für Projekte und Objektlieferungen können die Tische, auf Anfrage, mit einem Top in verschiedenen Finishes, auch in der feuerhemmenden Version 1IM, geliefert werden. Kostenvoranschlag je nach Ausführung und Anzahl.

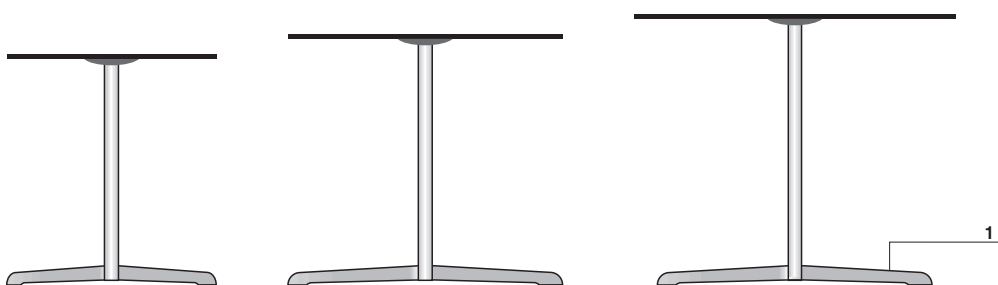

**STRUTTURA STRUCTURE STRUKTUR**

1: Pressofusione di alluminio verniciato color bronzo  
Die-cast aluminum painted bronze  
Aluminium-Druckguss in Bronzefarbe

**VERSIONE WENGÉ E RIGENERATO DI FIBRA DI CUOIO - VERSION WENGÉ AND REGENERATED LEATHER FIBRES - VERSION WENGÉ UND BONDED LEDER**

**CLUB TAVOLINO Ø 45**

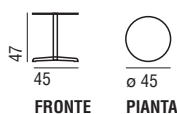

**CLUB TAVOLINO Ø 59**

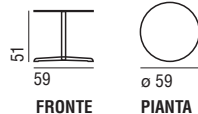

**CLUB TAVOLINO Ø 69**

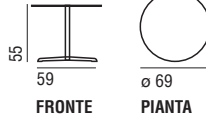

**VERSIONE MARMO - VERSION MARBLE - VERSION MARMOR**

**CLUB TAVOLINO Ø 45**

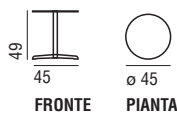

**CLUB TAVOLINO Ø 59**

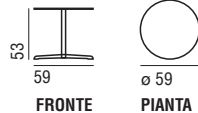

**CLUB TAVOLINO Ø 69**

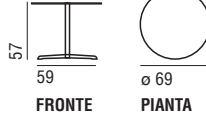





**Caratteristiche:** Argo, grazie al particolare disegno della base, è un tavolino idoneo ad essere affiancato ai modelli Elliot, Hampton, Hampton Memory, Holden, Itaca, Larsen, Link, Noe, Rubik e Zoe, offrendo un piano di appoggio pratico e funzionale. **Struttura:** Piano in MDF laccato opaco colore moka codice RAL 8019, spessore 15 mm., base in metallo verniciato nello stesso colore.

**Features:** The particular design of its base makes Argo an ideal match to models Elliot, Hampton, Hampton Memory, Holden, Itaca, Larsen, Link, Noe, Rubik and Zoe. Indeed, this small table serves as a practical and functional rest top. **Framework:** Table top in MDF, coffee brown colour-code RAL 8019, matt lacquered, thickness 15 mm.; base in metal, varnished in the same colouring.

**Eigenschaften:** Dank des speziellen Designs seines Gestells, ist Argo ein idealer Beistelltisch passend zu den Modellen Elliot, Hampton, Hampton Memory, Holden, Itaca, Larsen, Link, Noe, Rubik und Zoe, der eine praktische und zweckmäßige Ablagefläche bietet. **Struktur:** Tischplatte aus MDF Kaffeebraun Farbnummer RAL 8019, matt lackiert, Dicke 15 mm.; Metallgestell in gleicher Farbe lackiert.

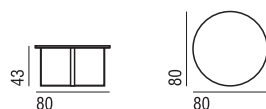

TAVOLINO ARGO

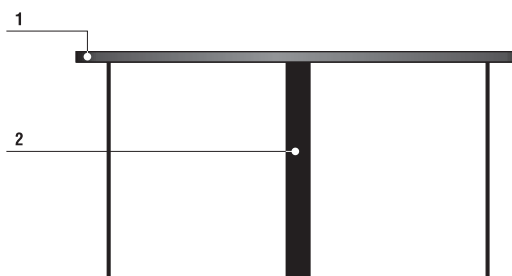

**STRUTTURA STRUCTURE STRUKTUR**

- 1:** MDF laccato opaco color moka.  
MDF coffee brown colouring, matt lacquered.  
MDF Kaffeebraun farbig, matt lackiert.
- 2:** Metallo verniciato color moka.  
Metal varnished, coffee brown colouring.  
Metall lackiert, Kaffeebraun farbig.



Verzelli  
Strada Langhirano, 215  
43124 Parma (Italy)  
ph +39 0521 648111  
fx +39 0521 648626  
www.verzelli.it  
verzelli@verzelli.it



ARTWORK  
Art direction  
Corrado Mantovani  
Antonella Frezza

Graphic design  
Europa. Atelier di comunicazione

Interior styling  
Antonella Frezza

CREDITS  
Photographers  
Nava Rapacchietta  
Alberto Tagliabue  
Gionata Xerra

Verzelli Photo Archive

L'Azienda si riserva di apportare ai suoi prodotti,  
senza alcun preavviso, tutte le modifiche tecniche  
e/o estetiche ritenute opportune.  
The Company reserves the right to introduce  
all the technical and/or aesthetic modifications deemed  
necessary to their products, without prior notice.

Copyright © 2022 Verzelli  
Printed in Italy



NEW LIFE TO YOUR COMFORT ZONE.



VERZELLONI